

SOUTHLAND TOOL MFG. INC.

Innovative Tools for Municipalities

GENERAL PRICE CATALOG

PUMA TOOLS

A Complete Line of Manhole Cleaning Tools and Accessories

FLAT TRAPS FOR SKIMMING ALONG FLAT AREAS

FT-6	6"	FLAT TRAP BASKET 6" WIDE X 6" HIGH
FT-8	8"	FLAT TRAP BASKET 8" WIDE X 6" HIGH
FT-10	10"	FLAT TRAP BASKET 10" WIDE X 6" HIGH
FT-12	12"	FLAT TRAP BASKET 12" WIDE X 8" HIGH
FT-15	15"	FLAT TRAP BASKET 15" WIDE X 8" HIGH

DEBRIS BASKETS TO USE WITH FIBERGLASS POLES

DB-6	6"	DEBRIS BASKET 6" FOR FIBERGLASS POLES
DB-8	8"	DEBRIS BASKET 8" FOR FIBERGLASS POLES
DB-10	10"	DEBRIS BASKET 10" FOR FIBERGLASS POLES
DB-12	12"	DEBRIS BASKET 12" FOR FIBERGLASS POLES
DB-15	15"	DEBRIS BASKET 15" FOR FIBERGLASS POLES
DB-18	18"	DEBRIS BASKET 18" FOR FIBERGLASS POLES
DB-24	24"	DEBRIS BASKET 24" FOR FIBERGLASS POLES

DEBRIS GRIT CATCHERS TO USE WITH FIBERGLASS POLES

DB-6S	6"	DEBRIS GRIT BASKET 6" WITH FIBERGLASS POLE CONNECTOR
DB-8S	8"	DEBRIS GRIT BASKET 8" WITH FIBERGLASS POLE CONNECTOR
DB-10S	10"	DEBRIS GRIT BASKET 10" WITH FIBERGLASS POLE CONNECTOR
DB-12S	12"	DEBRIS GRIT BASKET 12" WITH FIBERGLASS POLE CONNECTOR
DB-15S	15"	DEBRIS GRIT BASKET 15" WITH FIBERGLASS POLE CONNECTOR
DB-18S	18"	DEBRIS GRIT BASKET 18" WITH FIBERGLASS POLE CONNECTOR
DB-24S	24"	DEBRIS GRIT BASKET 24" WITH FIBERGLASS POLE CONNECTOR

Includes solid half bottom and back to catch fine grit

DEBRIS BASKETS WITH 25' ROPE

DBR-6	6"	DEBRIS BASKET 6" WITH ROPE
DBR-8	8"	DEBRIS BASKET 8" WITH ROPE
DBR-10	10"	DEBRIS BASKET 10" WITH ROPE
DBR-12	12"	DEBRIS BASKET 12" WITH ROPE
DBR-15	15"	DEBRIS BASKET 15" WITH ROPE
DBR-18	18"	DEBRIS BASKET 18" WITH ROPE
DBR-24	24"	DEBRIS BASKET 24" WITH ROPE

DEBRIS GRIT CATCHERS WITH 25' ROPE

DBR-6S	6"	DEBRIS GRIT CATCHER 6" WITH ROPE
DBR-8S	8"	DEBRIS GRIT CATCHER 8" WITH ROPE
DBR-10S	10"	DEBRIS GRIT CATCHER 10" WITH ROPE
DBR-12S	12"	DEBRIS GRIT CATCHER 12" WITH ROPE
DBR-15S	15"	DEBRIS GRIT CATCHER 15" WITH ROPE
DBR-18S	18"	DEBRIS GRIT CATCHER 18" WITH ROPE
DBR-24S	24"	DEBRIS GRIT CATCHER 24" WITH ROPE

Includes solid half bottom and back to catch fine grit

DEBRIS CYLINDERS

DC-6	6"	DEBRIS CYLINDER FOR 6" PIPE
DC-8	8"	DEBRIS CYLINDER FOR 8" PIPE
DC-10	10"	DEBRIS CYLINDER FOR 10" PIPE
DC-12	12"	DEBRIS CYLINDER FOR 12" PIPE



**All tools come standard with Quick-Connect Ends. Threaded ends for our poles available for additional \$10.
(Add "T" to end of part #.)**

ALUMINUM DEBRIS TRAPS, LIGHT AND NON-CORROSIVE ALUMINUM.

ADT-6	6"	ALUMINUM DEBRIS/SAND TRAP FOR USE WITH FIBERGLASS POLES
ADT-8	8"	ALUMINUM DEBRIS/SAND TRAP FOR USE WITH FIBERGLASS POLES
ADT-10	10"	ALUMINUM DEBRIS/SAND TRAP FOR USE WITH FIBERGLASS POLES
ADT-12	12"	ALUMINUM DEBRIS/SAND TRAP FOR USE WITH FIBERGLASS POLES
ADT-15	15"	ALUMINUM DEBRIS/SAND TRAP FOR USE WITH FIBERGLASS POLES
ADT-18	18"	ALUMINUM DEBRIS/SAND TRAP FOR USE WITH FIBERGLASS POLES



ALUMINUM DEBRIS TRAPS SAME AS ABOVE BUT WITH LOWERING ROPE.

ADR-6	6"	ALUMINUM DEBRIS/SAND TRAP WITH 25' LOWERING ROPE
ADR-8	8"	ALUMINUM DEBRIS/SAND TRAP WITH 25' LOWERING ROPE
ADR-10	10"	ALUMINUM DEBRIS/SAND TRAP WITH 25' LOWERING ROPE
ADR-12	12"	ALUMINUM DEBRIS/SAND TRAP WITH 25' LOWERING ROPE
ADR-15	15"	ALUMINUM DEBRIS/SAND TRAP WITH 25' LOWERING ROPE
ADR-18	18"	ALUMINUM DEBRIS/SAND TRAP WITH 25' LOWERING ROPE



SCOOPAS

SC-4	4"	4" SCOOPA FOR FIBERGLASS POLES
SC-6	6"	6" SCOOPA FOR FIBERGLASS POLES
SC-8	8"	8" SCOOPA FOR FIBERGLASS POLES
SC-10	10"	10" SCOOPA FOR FIBERGLASS POLES
SC12	12"	12" SCOOPA FOR FIBERGLASS POLES



SCOOPAS SCREENS KEEPS FLOW FROM SPILLING OVER BACK OF TOOL

SCCS-6	6"	6" SCOOPA SCREEN FOR FIBERGLASS POLES
SCCS-8	8"	8" SCOOPA SCREEN FOR FIBERGLASS POLES
SCCS-10	10"	10" SCOOPA SCREEN FOR FIBERGLASS POLES
SCCS-12	12"	12" SCOOPA SCREEN FOR FIBERGLASS POLES



PIKE POLE ATTACHMENT

PP-125		PIKE POLE ATTACHMENT FOR POLES
--------	--	--------------------------------



CHOPPER

LC-9	6"	CURVED CHOPPER FOR FIBERGLASS OR WOOD POLE GREASE LOG CHOPPER NOW WITH CURVED SIDE TO BETTER PUSH MATERIAL.
------	----	---



SEWER HOSE GRABBERS

HG-1	9" LONG	IMPROVED HOSE GRABBER FOR FIBERGLASS POLE OR WOOD ANGLED ENDS TO ALLOW EASY ENTRY FOR HOSE.
------	---------	---



SHT-1	OPPOSITE HOSE GRABBER, OPPOSING C HOOKS GRAB HOSE IN MIDDLE	
-------	---	--



DEBRIS GRABBERS, HOOKS, CLAWS, SHOVELS, SPOONS, MAGNETS

4PG-1	8" WIDE	4 PRONGED DEBRIS GRABBER
-------	---------	--------------------------



3PG-1	6" WIDE	3 PRONGED DEBRIS GRABBER.SAME AS ABOVE BUT 3 PRONGS.
-------	---------	--



BITZ-R		12" LONG BITZ RAKE. GREAT FOR GETTING MATERIAL OUT OF INVERT AND CAN BE INSERTED INTO PIPE FOR CATCHING HANGING MATERIAL
--------	--	--



ALL TOOLS ARE AVAILABLE WITH THREADED ENDS FOR OUR POLES
(ADD "T" TO PART NUMBER AND ADD\$ 10.00)

CRW-1 CRAW FOR ATTACHING TO POLES, INCLUDES ROPE AND INSTRUCTIONS
INCLUDES CRAW, ROPE, PVC STAY, ONE-WAY CLEAT, HARDWARE
AND ALL YOU NEED TO CONNEC TO OUR FIBERGLASS POLES AND EXTEND TO
24' OR MORE DEPENDING ON THE LENGTH YOU NEED.

SR3-1 3 PRONGED 90° RAKE

PS-1 9" DIA. ROUNDED CATCH BASIN SPOON. CONNECTS TO ALL OUR POLES

CAM-1 CAMERA GAFFING HOOK. TESTED TO 200 LBS. (LEFT)
CAM-2 SMALL DIAMETER CAMERA GAFFING HOOK 3" (RIGHT)

SSCAM-1S 2" SIDE TO SIDE CAMERA SWIVEL HOOK

ECL-1 ENVIROTYPE CAMERA LIFTING HOOK WITH SIDE PICK UP BARS AND POLE ADAPTER

SMAG-1 SEWER MAGNET, 100LB CAPACITY, AN OVERALL METAL RETRIEVER GREAT
TOOL FOR RETRIEVING THAT LOST TOOL, CAN LIFT VALVE COVERS - COMES
WITH STEEL PROTECTIVE PLATE.

SIS-1 INVERT SHOVEL ATTACHMENT - ATTACHES TO ALL OUR POLE
SYSTEMS, GREAT FOR DIGGING, MOVING DEBRIS IN INVERT.

FS-IT FLAT SHOVEL ATTACHMENT ATTACHES TO ALL OUR POLE SYSTEMS

GH-1 GRAPPLING HOOK WITH 25' OF POLY ROPE, 3 PRONG

CATCH BASIN SPOON ASSEMBLIES

FS-6 6' CATCH BASIN SPOON WITH ONE 6' FIBERGLASS POLE
FS-12 12' CATCH BASIN SPOON WITH 12' OF FIBERGLASS POLE
FS-18 18' CATCH BASIN SPOON WITH 18' OF FIBERGLASS POLE

OSH STYLE WOOD SPOONS

PS-6 6' 1.5" THICK ASH HANDLE AND CATCH BASIN SPOON (ONE PIECE)
PS-8 8' 1.5" THICK ASH HANDLE AND CATCH BASIN SPOON (ONE PIECE)
PS-10 10' 1.5" THICK ASH HANDLE AND CATCH BASIN SPOON (ONE PIECE)
PS-102 10' 1.5" THICK ASH HANDLE AND CATCH BASIN SPOON (TWO PIECE)
PS-122 12' 1.5" THICK ASH HANDLE AND CATCH BASIN SPOON (TWO PIECE)
PS-162 16' 1.5" THICK ASH HANDLE AND CATCH BASIN SPOON (TWO PIECE)
PS-182 18' 1.5" THICK ASH HANDLE AND CATCH BASIN SPOON (THREE PIECE)
PS-20S 20' 1.5" THICK ASH HANDLE AND CATCH BASIN SPOON (THREE PIECE)



FIBERGLASS POLE GRABBER

- | | | |
|---------|----------|--|
| GWCT-15 | 15' LONG | GRABBER WITH SPRING LOADED CLAW ACTION TELESCOPIC FIBERGLASS POLE FROM 7'-15' (see below) |
| GWCT-16 | 16' LONG | SAME AS ABOVE BUT EXTENDED ADDITIONAL FOOT. OVERALL 16' LONG ALL ABOVE GRABBERS COME WITH SPECIAL CLARK CLIP TO ALLOW YOU TO REMOVE THE HEAD EASILY WITHOUT HAVING TO UNDUE KNOTS. ALLOWS YOU TO CHANGE FROM CLAW TOOL TO ANY OTHER TOOL IN THE PUMA LINE. |



STEEL DEBRIS GRABBER

- | | | |
|--------|----------|---|
| SGP-15 | 15' LONG | STEEL TELESCOPIC GRABBER PRONG EXTENDS FROM 5' TO 15' |
| SGP-21 | 21' LONG | STEEL TELESCOPIC GRABBER PRONG EXTENDS FROM 7' TO 21' |
| SGP-24 | 24' LONG | STEEL TELESCOPIC GRABBER PRONG EXTENDS FROM 8' TO 24' |



PUMA GRABBER

(3 PRONGS THAT STAY CLOSED WHEN OBJECT IS REMOVED)

- | | | |
|---------|----------|------------------------------------|
| PMA-6S | 6' LONG | PUMA GRABBER 6' LONG WITH 8" JAWS |
| PMA-8S | 8' LONG | PUMA GRABBER 8' LONG WITH 8" JAWS |
| PMA-10S | 10' LONG | PUMA GRABBER 10' LONG WITH 8" JAWS |
| PMA-12S | 12' LONG | PUMA GRABBER 12' LONG WITH 8" JAWS |
| PMA-15S | 15' LONG | PUMA GRABBER 15' LONG WITH 8" JAWS |
| PMA-18S | 18' LONG | PUMA GRABBER 18' LONG WITH 8" JAWS |
- NOTE: ALSO AVAILABLE WITH LARGER OPENING PRONGS

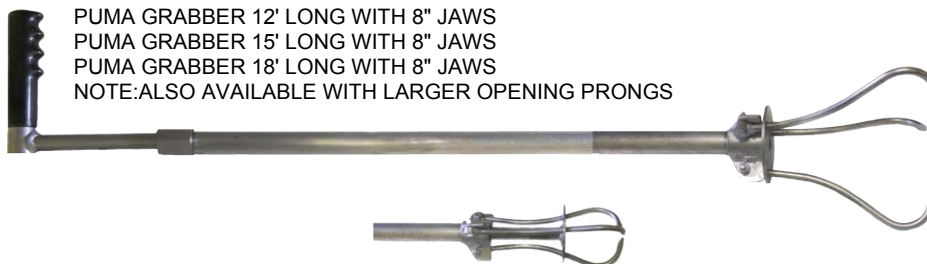

HANDY-CLAMS

- | | | |
|--------|-----|---|
| SHC-6 | 6' | HANDY CLAM 6' LONG WITH SMALL 12" BUCKET |
| SHC-8 | 8' | HANDY CLAM 8' LONG WITH SMALL 12" BUCKET |
| SHC-10 | 10' | HANDY CLAM 10' LONG WITH SMALL 12" BUCKET |
| SHC-12 | 12' | HANDY CLAM 12' LONG WITH SMALL 12" BUCKET |
| SHC-16 | 16' | HANDY CLAM 16' LONG WITH SMALL 12" BUCKET |
| SHC-18 | 18' | HANDY CLAM 18' LONG WITH SMALL 12" BUCKET |
| SHC-20 | 20' | HANDY CLAM 20' LONG WITH SMALL 12" BUCKET |
| SHC-25 | 25' | HANDY CLAM 25' LONG WITH SMALL 12" BUCKET |

ALSO AVAILABLE WITH 16" BUCKET. ADD "6" TO PART. PRICE IS THE SAME. ONE PIECE, (EXPENSIVE TO SHIP OR KNOCKDOWN MODEL THAT REDUCED SHIPPING COST) EXAMPLE: 18' CAN BE USED AS A 6', 12' AND 18'.



QUICK CONNECT POLE SETS FOR THE PUMA LINE OF TOOLS

FIBERGLASS POLES STANDARD WEIGHT ORANGE

- | | | |
|---------|--------|---|
| STD-6 | 6' | SINGLE MALE X FEMALE POLE |
| STD-3 | 3' | SINGLE MALE X FEMALE POLE |
| STD-24 | 24' | SET OF 3 MALE X FEMALE POLE AND ONE END POLE FEMALE X RUBBER END POLE |
| STD-21 | 21' | SET OF 3 X 6' AND 1 X 3' MALE X FEMALE POLE |
| STD-18 | 18' | SET OF 2 MALE X FEMALE POLE AND ONE END POLE FEMALE X RUBBER END |
| STD-14R | 14' | SINGLE 14' POLE WITH FEMALE END X RUBBER END |
| STD-12R | 12' | SINGLE 12' POLE WITH FEMALE END X RUBBER END |
| STD6-R | 6' | SINGLE 6' FEMALE X RUBBER END POLE |
| EXT-1 | 7'-14' | FIBERGLASS EXTENSION POLE 7' - 14" |



STEEL REINFORCED FIBERGLASS POLES (SUPER STIFF)

STD-6ST	6'	SINGLE MALE X FEMALE POLE
STD-8ST	8'	SINGLE MALE X FEMALE POLE
STD-3ST	3'	SINGLE MALE X FEMALE POLE
STD-24ST	24'	SET OF 3 MALE X FEMALE POLE AND ONE END FEMALE X RUBBER END POLE
STD-21ST	21'	SET OF 3 X 6' AND 1 X 3' MALE X FEMALE POLE



FOAM FILLED POLES FOR EXTRA STRENGTH AND SAFETY

FF-6	6'	SINGLE MALE X FEMALE POLE
FF-3	3'	SINGLE MALE X FEMALE POLE
FF-24	24'	SET OF 3 MALE X FEMALE POLE AND ONE END FEMALE X RUBBER END POLE
FF-21	21'	SET OF 3 X 6' AND 1 X 3' MALE X FEMALE POLE
FF-6R	6'	SINGLE 6' FEMALE X RUBBER END POLE

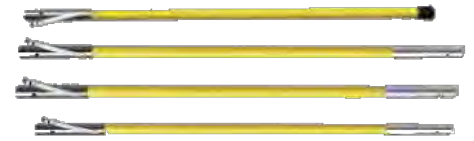

THREADED END POLES. SPECIAL COARSE SUPER STRONG EASY THREAD DESIGN

THREADED ENDS – FIBERGLASS POLES STANDARD WEIGHT ORANGE

STD-6T	6'	SINGLE MALE X FEMALE POLE
STD-3T	3'	SINGLE MALE X FEMALE POLE
STD-24T	24'	SET OF 3 MALE X FEM AND 1 END MALE X RUBBER END
STD-21T	21'	SINGLE 6' MALE X RUBBER END POLE
STD-18T	18'	SET OF 2 MALE X FEMALE POLE AND 1 END MALE X RUBBER END
STD-14RT	14'	SINGLE 14' POLE WITH MALE END X RUBBER END
STD-12RT	12'	SINGLE 12' POLE WITH MALE END X RUBBER END
STD-6RT	6'	SINGLE 6' MALE X RUBBER END POLE



EXT-1T 7'-14' FIBERGLASS EXTENSION POLE 7' - 14'

THREADED ENDS – STEEL REINFORCED FIBERGLASS POLES
(OUR STRONGEST, MOST HEAVY DUTY POLE)

STD-6STT	6'	SINGLE MALE X FEMALE POLE
STD-3STT	3'	SINGLE MALE X FEMALE POLE
STD-24STT	24'	SET OF 3 MALE X FEMALE POLE AND ONE END POLE MALE X RUBBER END POLE
STD-21STT	21'	SET OF 3 X 6' AND 1 X 3' MALE X FEMALE POLE
STD-18STT	21'	SET OF 2 MALE X FEMALE POLE & 1 END POLE MALE X RUBBER END



THREADED ENDS – FOAM FILLED POLES FOR EXTRA STRENGTH

FF6T	6'	SINGLE MALE X FEMALE POLE
FF3T	3'	SINGLE MALE X FEMALE POLE
FF24T	24'	SET OF 3 MALE X FEMALE POLE AND ONE END POLE MALE X RUBBER END POLE
FF21T	21'	SET OF 3 X 6' AND 1 X 3' MALE X FEMALE POLE
FF6RT	6'	SINGLE 6' MALE X RUBBER END POLE

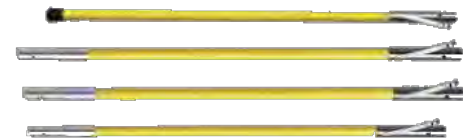

ALUMINUM POLE WITH ALUMINUM QUICK CONNECT ENDS

AP-6	6'	ALUMINUM POLE WITH ALUMINUM QUICK CONNECTS ENDS MXF
AP-12	12'	SET OF 2 ALUMINUM POLES 12' TOTAL MALE X FEMALE
AP-18	18'	SET OF 3 ALUMINUM POLES 18' TOTAL MALE X FEMALE
AP-24	24'	SET OF 4 ALUMINUM POLES 24' TOTAL MALE X FEMALE



POLE CARRIERS

SDS-1	SINGLE SET OF POLE CARRIERS. Easily attaches to your vehicle
SDS-2	DUAL SET OF POLE CARRIERS

VAC-TRAPS SHORT BACK LIGHTER DESIGN

VECTOR FLAT FLANGE TYPE

BT-6	6"	6" VAC-TRAP FOR 8" VECTOR SUCTION TUBE FLAT
BT-8	8"	8" VAC-TRAP FOR 8" VECTOR SUCTION TUBE FLAT
BT-10	10"	10" VAC-TRAP FOR 8" VECTOR SUCTION TUBE FLAT
BT-12	12"	12" VAC-TRAP FOR 8" VECTOR SUCTION TUBE FLAT
BT-15	15"	15" VAC-TRAP FOR 8" VECTOR SUCTION TUBE FLAT
BT-18	18"	18" VAC-TRAP FOR 8" VECTOR SUCTION TUBE FLAT
BT-24	24"	24" VAC-TRAP FOR 8" VECTOR SUCTION TUBE FLAT

VECTOR FLAT FLANGE TYPE(With Grit Covers)

BT-6S	6"	6" VAC-TRAP GRIT FOR 8" VECTOR SUCTION TUBE FLAT
BT-8S	8"	8" VAC-TRAP GRIT FOR 8" VECTOR SUCTION TUBE FLAT
BT-10S	10"	10" VAC-TRAP GRIT FOR 8" VECTOR SUCTION TUBE FLAT
BT-12S	12"	12" VAC-TRAP GRIT FOR 8" VECTOR SUCTION TUBE FLAT
BT-15S	15"	15" VAC-TRAP GRIT FOR 8" VECTOR SUCTION TUBE FLAT
BT-18S	18"	18" VAC-TRAP GRIT FOR 8" VECTOR SUCTION TUBE FLAT
BT-24S	24"	24" VAC-TRAP GRIT FOR 8" VECTOR SUCTION TUBE FLAT

CAMEL STYLE FEMALE END

CT-6	6"	6" VAC-TRAP FOR 8" CAMEL TYPE FEMALE END
CT-8	8"	8" VAC-TRAP FOR 8" CAMEL TYPE FEMALE END
CT-10	10"	10" VAC-TRAP FOR 8" CAMEL TYPE FEMALE END
CT-12	12"	12" VAC-TRAP FOR 8" CAMEL TYPE FEMALE END
CT-15	15"	15" VAC-TRAP FOR 8" CAMEL TYPE FEMALE END
CT-18	18"	18" VAC-TRAP FOR 8" CAMEL TYPE FEMALE END
CT-24	24"	24" VAC-TRAP FOR 8" CAMEL TYPE FEMALE END

CAMEL STYLE FEMALE END (with grit covers)

CT-6S	6"	6" VAC-TRAP GRIT FOR 8" CAMEL TYPE FEMALE END
CT-8S	8"	8" VAC-TRAP GRIT FOR 8" CAMEL TYPE FEMALE END
CT-10S	10"	10" VAC-TRAP GRIT FOR 8" CAMEL TYPE FEMALE END
CT-12S	12"	12" VAC-TRAP GRIT FOR 8" CAMEL TYPE FEMALE END
CT-15S	15"	15" VAC-TRAP GRIT FOR 8" CAMEL TYPE FEMALE END
CT-18S	18"	18" VAC-TRAP GRIT FOR 8" CAMEL TYPE FEMALE END
CT-24S	24"	24" VAC-TRAP GRIT FOR 8" CAMEL TYPE FEMALE END

AQUATECH FEMALE COUPLING END

AT-6	6"	VAC-TRAP FOR 8" AQUATECH TYPE FEMALE END
AT-8	8"	VAC-TRAP FOR 8" AQUATECH TYPE FEMALE END
AT-10	10"	VAC-TRAP FOR 8" AQUATECH TYPE FEMALE END
AT-12	12"	VAC-TRAP FOR 8" AQUATECH TYPE FEMALE END
AT-15	15"	VAC-TRAP FOR 8" AQUATECH TYPE FEMALE END
AT-18	18"	VAC-TRAP FOR 8" AQUATECH TYPE FEMALE END

AQUATECH FEMALE COUPLING END (with grit covers)

AT-6S	6"	VAC-TRAP GRIT FOR 8" AQUATECH TYPE FEMALE END
AT-8S	8"	VAC-TRAP GRIT FOR 8" AQUATECH TYPE FEMALE END
AT-10S	10"	VAC-TRAP GRIT FOR 8" AQUATECH TYPE FEMALE END
AT-12S	12"	VAC-TRAP GRIT FOR 8" AQUATECH TYPE FEMALE END
AT-15S	15"	VAC-TRAP GRIT FOR 8" AQUATECH TYPE FEMALE END
AT-18S	18"	VAC-TRAP GRIT FOR 8" AQUATECH TYPE FEMALE END

VAC-ALL MALE COUPLING END

JT-6	6"	VAC-TRAP FOR 8" VAC-ALL MALE END
JT-8	8"	VAC-TRAP FOR 8" VAC-ALL MALE END
JT-10	10"	VAC-TRAP FOR 8" VAC-ALL MALE END
JT-12	12"	VAC-TRAP FOR 8" VAC-ALL MALE END
JT-15	15"	VAC-TRAP FOR 8" VAC-ALL MALE END
JT-18	18"	VAC-TRAP FOR 8" VAC-ALL MALE END

VAC-ALL MALE COUPLING END (with grit covers)

JT-6S	6"	VAC-TRAP GRIT FOR 8" VAC-ALL MALE END
JT-8S	8"	VAC-TRAP GRIT FOR 8" VAC-ALL MALE END
JT-10S	10"	VAC-TRAP GRIT FOR 8" VAC-ALL MALE END
JT-12S	12"	VAC-TRAP GRIT FOR 8" VAC-ALL MALE END
JT-15S	15"	VAC-TRAP GRIT FOR 8" VAC-ALL MALE END
JT-18S	18"	VAC-TRAP GRIT FOR 8" VAC-ALL MALE END

ADD "6" TO END OF PART # FOR 6" UP-TUBE FOR ANY VAC TRAP. SAME PRICE

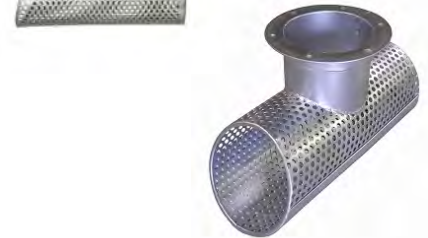

JETTING AND VACUUM TOOLS AND ACCESSORIES

SEWER HOSE PROTECTION EQUIPMENT

- LMER-1 LOWER MANHOLE EASEMENT ROLLER

- SJS-1 TIGER TAIL 3" X 36"
- SJS-2 TIGER TAIL 2" X 36"

- SJS-HD HEAVY DUTY PUMA HOSE GUIDE 3"
Smooth Bore Rubber Hose, Steels banded cuffs, King Clamp rope

- SJ2-HD HEAVY DUTY PUMA HOSE GUIDE 2"

- SAMR-1 UPPER MANHOLE ROLLER GUIDE (ALUMINUM) NYLON ROLLER
- SASR-1 UPPER MANHOLE ROLLER GUIDE (STEEL) NYLON ROLLER

- SAMA-1 UPPER MANHOLE ROLLER GUIDE (ALUMINUM) ALUMINUM ROLLER

- SAYR-1 UPPER MANHOLE "Y" ROLLER FOR 8" TUBE



SPECIAL HOSE GUIDES

- HGR-1 HOSE GUIDE ROLLER-GRABBER FOR FIBERGLASS POLES
- HRG-1T HOSE GUIDE ROLLER-GRABBER FOR THREADED POLES

- STR-1 ROLLER FOR CORRUGATED PIPE PROTECTS YOUR HOSE

- GTT-7 TIGER TAIL 5 ROLLER GUIDE. WITH 25' ROPE.

- SDA-2 ARTICULATING ROLLER GUIDE

- SHDS-1 ALUMINUM LOWER MANHOLE ROLLER GUIDE SHOE (4 NYLON ROLLERS)
3/4" THREADED CONNECTION. POLES NOT INCLUDED.

- FE-1 POLE ADAPTER. CONNECT 3/4" THREADED NPT TO QUICK CONNECT
POLES

- SHDS-1ST STEEL LOWER MANHOLE ROLLER GUIDE SHOE.(4 NYLON ROLLERS)
3/4" THREADED CONNECTION. POLES NOT INCLUDED.

Can be supplied with pole connector, no extra charge

- ADJ-1 ADJUSTABLE TOP MANHOLE ROLLER. Tubular steel slides to
Manholes from 24" to 36".Opposing brackets grab manhole ring.

- SSC-24 ANTI-SPLASH MANHOLE ROLLER GUIDE FOR 24"
- SSC-36 ANTI-SPLASH MANHOLE ROLLER GUIDE FOR 36"

- SSR-5 STAKE ROLLER FOR HOSE TO GO AROUND BENDS
Hardened point and head. Spade to keep from turning



DROP MANHOLE BRIDGE

- DMB-1 8" DROP MANHOLE BRIDGE, 48" LONG, BRIDGES THE DROP
INCLUDES POLE CONNECTOR AND 25' OF ROPE FOR LEVELING
- DMB-2 8" DROP MANHOLE BRIDGE, 60" LONG, BRIDGES THE DROP
- DMB-1S 6" DROP MANHOLE BRIDGE, 48" LONG, BRIDGES THE DROP
- DMB-1-24 DROP MANHOLE BRIDGE KIT. COMES WITH SET OF POLES
24' LONG STD-24. CHOOSE EITHER 6" OR 8" SIZE PIPE.

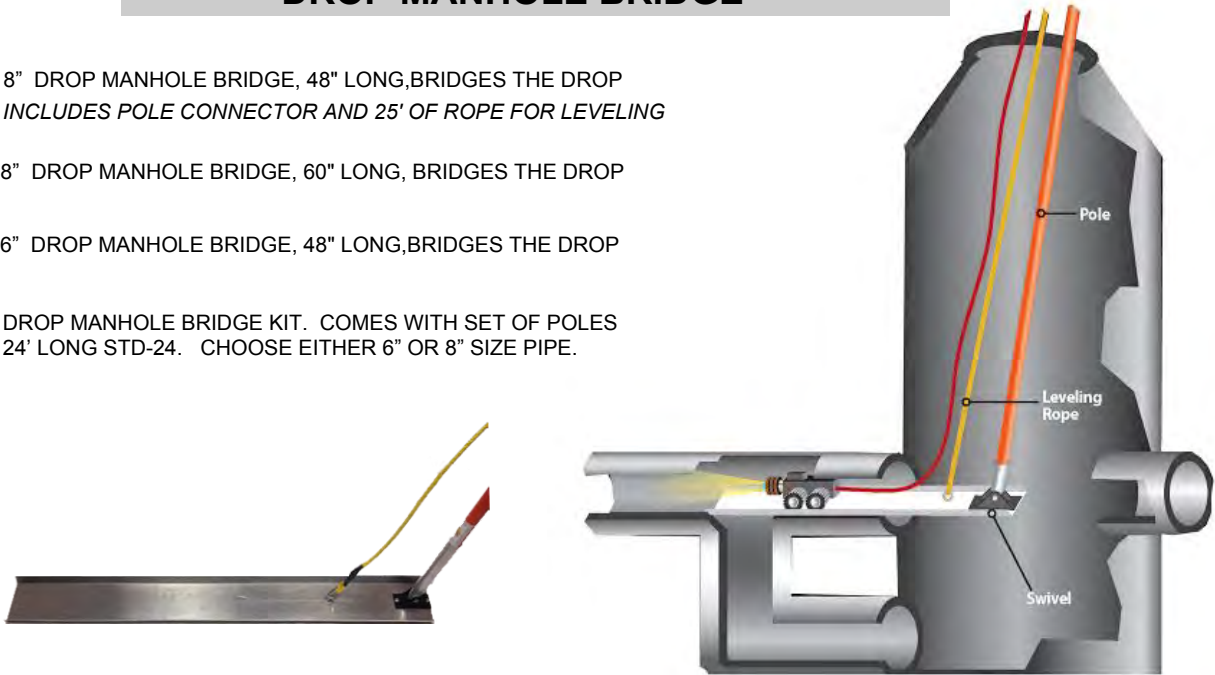

VACUUM TUBE ACCESSORIES

- HYH-4 4" 4" HYDRO-VAC HANDLE. Handles vacuum tubes or hoses
- HYH-6 6" 6" HYDRO-VAC HANDLE. Handles vacuum tubes for Hydro
- HYH-8 8" 8" HYDRO-VAC HANDLE. Handles vacuum tubes for Hydro

- VC-8 "V" CLAMP FOR CONNECTING FLAT FLANGE TUBES.
VACTOR/VAC-CON. NICE PADDLE CLOSURE IS EASY
TO CLOSE. FULLY PLATED FOR LONG LIFE. NO
ADJUSTMENT NECESSARY.



DEEP MANHOLE TUBE HOLDER (PAT.PEND.)

- DTH-8 8" 8" Deep Tube Holder. Use to lower tubes into manhole. FOR 36"
- DTH-6 6" 6" Deep Tube Holder. Use to lower tubes into manhole. FOR 36"
- DTH-50 8" 8" Deep Tube Holder. Extended arm to 50" length
- DTH-60 8" 8" Deep Tube Holder. Extended arm to 60" length



CROWN NOZZLE REDUCERS

The RCN8SS series has a reduced entrance of 5" and contains 1" holes above the debris field to work as a snorkel.

- RCN8SS 8" X 5.5" 12" long Crown Nozzle reducer to get into the invert. - Vactor Style
- RCN8SSC 8" X 5.5" 12" long Crown Nozzle reducer to get into the invert.- Camel Styl
- RCN8SSV 8" X 5.5" 12" long Crown Nozzle reducer to get into the invert.- Vac-All Style
- RCN8SSA 8" X 5.5" 12" long Crown Nozzle reducer to get into the invert - Aquatech Style



HYDRO-EXCAVATOR TOOL

HYDRO-EXCAVATOR TOOL 'DIG-IT' IS A LIGHTWEIGHT ATTACHMENT FOR YOUR SEWER HOSE, WITH SEWER HOSE SIZES (3/4' OR 1') AND SUCTION TUBES SIZES (6' OR 8'). THE WET RING HAS EITHER 4,8 OR 10 REPLACEABLE STAINLESS STEEL JETS ACCORDING TO YOUR GPM AND PSI. JETS ARE SLIGHTLY ANGLED AND ZERO DEGREES. BOTTOM RUBBER CUFF PROVIDES PROTECTION.

<u>PART NO.</u>	<u>MACHINE</u>	<u>TUBE SIZE</u>	<u>HOSE</u>	<u>JETS</u>
HY-EX-8V4-3/4	VACTOR/VAC-CON	8"	3/4"	4
HY-EX-8V8-3/4	VACTOR/VAC-CON	8"	3/4"	8
HY-EX-8V10-3/4	VACTOR/VAC-CON	8"	3/4"	10
HY-EX-8V4-1	VACTOR/VAC-CON	8"	1"	4
HY-EX-8V8-1	VACTOR/VAC-CON	8"	1"	8
HY-EX-8V10-1	VACTOR/VAC-CON	8"	1"	10
HY-EX-8C4-3/4	CAMEL	8"	3/4"	4
HY-EX-8C8-3/4	CAMEL	8"	3/4"	8
HY-EX-8C10-3/4	CAMEL	8"	3/4"	10
HY-EX-8C4-1	CAMEL	8"	1"	4
HY-EX-8C8-1	CAMEL	8"	1"	8
HY-EX-8C10-1	CAMEL	8"	1"	10
HY-EX-8J4-3/4	VAC-ALL	8"	3/4"	4
HY-EX-8J8-3/4	VAC-ALL	8"	3/4"	8
HY-EX-8J10-3/4	VAC-ALL	8"	3/4"	10
HY-EX-8J4-1	VAC-ALL	8"	1"	4
HY-EX-8J8-1	VAC-ALL	8"	1"	8
HY-EX-8J10-1	VAC-ALL	8"	1"	10
HY-EX-6V4-3/4	VACTOR/VAC-CON	6"	3/4"	4
HY-EX-6V8-3/4	VACTOR/VAC-CON	6"	3/4"	8
HY-EX-6V10-3/4	VACTOR/VAC-CON	6"	3/4"	10
HY-EX-6V4-1	VACTOR/VAC-CON	6"	1"	4
HY-EX-6V8-1	VACTOR/VAC-CON	6"	1"	8
HY-EX-6V10-1	VACTOR/VAC-CON	6"	1"	10
HY-EX-6C4-3/4	CAMEL	6"	3/4"	4
HY-EX-6C8-3/4	CAMEL	6"	3/4"	8
HY-EX-6C10-3/4	CAMEL	6"	3/4"	10
HY-EX-6C4-1	CAMEL	6"	1"	4
HY-EX-6C8-1	CAMEL	6"	1"	8
HY-EX-6C10-1	CAMEL	6"	1"	10
HY-EX-6J4-3/4	VAC-ALL	6"	3/4"	4
HY-EX-6J8-3/4	VAC-ALL	6"	3/4"	8
HY-EX-6J10-3/4	VAC-ALL	6"	3/4"	10
HY-EX-6J4-1	VAC-ALL	6"	1"	4
HY-EX-6J8-1	VAC-ALL	6"	1"	8
HY-EX-6J10-1	VAC-ALL	6"	1"	10

*Only 20 lbs. and 13' tall for easy storage.



Above pictured with our hydro-vac handle HYH-8 \$99 each. (Suction tube not included)



TUBE HOSE CLAMPS (KEEPS YOUR HOSE STEADY AT EVERY CONNECTION)

THV-8 TUBE HOSE CLAMP	VACTOR/VAC-CON	8"
THV-6 TUBE HOSE CLAMP	VACTOR/VAC-CON	6"
THC-8 TUBE HOSE CLAMP	CAMEL/VAC-ALL	8"
THC-6 TUBE HOSE CLAMP	CAMEL/VAC-ALL	6"

Tube Hose Clamp THC-8 has jaws that open to grab your hose at the flange .

HYDRAULIC ROOT CUTTERS (MOTORS AND KITS)

PUMA HYDRAULIC ROOT SAW CUTTER KIT

SHYK-1	1"	HYDRAULIC ROOT CUTTER KIT. INCLUDES: 4 EASY SKIDS AND 4 SAWS FOR 6", 8", 10" AND 12" INCLUDES 1" HUB, ARBOR TOOL AND TOOL BOX
SHYK-34	3/4"	
SHYK-13	1"	SAME AS ABOVE BUT WITH 3 SAWS AND SKIDS, 6" , 8" 10" SAME AS ABOVE BUT WITH 3 SAWS AND SKIDS, 6" , 8" 10"
SHYK-33	3/4"	
SHYM-1	1"	HYDRAULIC ROOT CUTTER MOTOR ONLY PUMA STYLE 1" HYDRAULIC ROOT CUTTER MOTOR ONLY PUMA STYLE 3/4"
SHYM3/4	3/4"	



SKIDS FOR PUMA ROOT CUTTERS

SS-6	6"	6" EASY ROOT CUTTER SKID WITH 6 RAILS
SS-8	8"	8" EASY ROOT CUTTER SKID WITH 3 RAILS
SS-10	10"	10" EASY ROOT CUTTER SKID WITH 3 RAILS
SS-12	12"	12" EASY ROOT CUTTER SKID WITH 3 RAILS
SS-15	15"	15" EASY ROOT CUTTER SKID WITH 3 RAILS
SS-18	18"	18" EASY ROOT CUTTER SKID WITH 3 RAILS
SS-20	20"	20" EASY ROOT CUTTER SKID WITH 3 RAILS
SS-22	22"	22" EASY ROOT CUTTER SKID WITH 3 RAILS
SS-24	24"	24" EASY ROOT CUTTER SKID WITH 3 RAILS



PUMA ROUND BODY HYDRAULIC ROOT CUTTER

SRRC-1	ROUND BODY HYDRAULIC ROOT CUTTER
SRRK-1	ROUND BODY KIT 4 SKIDS/SAWS



SKIDS FOR ROUND BODY PUMA ROOT CUTTERS

RBS-4	4"	4" SKID DONUTS FOR ROUND BODY ROOT CUTTER
RBS-6	6"	6" SKID FOR ROUND BODY ROOT CUTTER
RBS-8	8"	8" SKID FOR ROUND BODY ROOT CUTTER
RBS-10	10"	10" SKID FOR ROUND BODY ROOT CUTTER
RBS-12	12"	12" SKID FOR ROUND BODY ROOT CUTTER
RBS-15	15"	15" SKID FOR ROUND BODY ROOT CUTTER
RBS-18	18"	18" SKID FOR ROUND BODY ROOT CUTTER
RBAS81	8"-10"	8" -10" ADJUSTABLE WHEELED SKID FOR ROUND BODY



HI-TORQUE HYDRAULIC ROOT SAW CUTTER KIT AND MOTORS

S906K-1	HI-TORQUE - HYDRAULIC ROOT CUTTER KIT. INCLUDES: 4 EASY SKIDS AND 4 SAWS FOR 6", 8", 10" AND 12" INCLUDES 1" HUB, ARBOR TOOL AND TOOL BOX
S906K-3/4	SAME AS ABOVE BUT FOR 3/4" HOSE. SPECIFY PSI/GPM
S906M-1	HI-TORQUE HYDRAULIC ROOT CUTTER MOTOR ONLY 1"
S906M34	HI-TORQUE HYDRAULIC ROOT CUTTER MOTOR ONLY 3/4"
DTC-8-K	DIAMOND TAP CUTTER KIT, INCLUDES S906M-1 MOTOR, 8" CUTTER DTC-8 , TOOL BOX, ARBOR TOOL, ALLEN WRENCH.



SKIDS FOR HI-TORQUE STYLE ROOT CUTTERS:

STSS-6	6"	6" EASY ROOT CUTTER SKID WITH 6 RAILS
STSS-8	8"	8" EASY ROOT CUTTER SKID WITH 3 RAILS
STSS-10	10"	10" EASY ROOT CUTTER SKID WITH 3 RAILS
STSS-12	12"	12" EASY ROOT CUTTER SKID WITH 3 RAILS
STSS-15	15"	15" EASY ROOT CUTTER SKID WITH 3 RAILS
STSS-18	18"	18" EASY ROOT CUTTER SKID WITH 3 RAILS
STSS-20	20"	20" EASY ROOT CUTTER SKID WITH 3 RAILS
STSS-22	22"	22" EASY ROOT CUTTER SKID WITH 3 RAILS
STSS-24	24"	24" EASY ROOT CUTTER SKID WITH 3 RAILS
GFR-6	6"	GOPHER ROOT SAW SKID ASSEMBLY WITH FRONT RING & REAR COLLAR
GFR-6	8"	GOPHER ROOT SAW SKID ASSEMBLY WITH FRONT RING & REAR COLLAR
GFR-6	10"	GOPHER ROOT SAW SKID ASSEMBLY WITH FRONT RING & REAR COLLAR
GFR-6	12"	GOPHER ROOT SAW SKID ASSEMBLY WITH FRONT RING & REAR COLLAR
GFR-6	15"	GOPHER ROOT SAW SKID ASSEMBLY WITH FRONT RING & REAR COLLAR



LATERAL ROOT CUTTER

- S9031/2 1/2" SMALL DIAMETER ROOT CUTTER WITH 5/8" SHAFT
- S903-1 1" SMALL DIAMETER ROOT CUTTER WITH 5/8" SHAFT
- LKS-3 LATERAL ROOT CUTTER SKID FOR 3" PIPE
- LKS-4 LATERAL ROOT CUTTER SKID FOR 4" PIPE
- LKS-6 LATERAL ROOT CUTTER SKID FOR 6" PIPE
- LKS-8 LATERAL ROOT CUTTER SKID FOR 8" PIPE

- RSH-58 5/8" HUB FOR HYDRAULIC ROOT CUTTER SAW



ROOT CUTTER ACCESSORIES

- SAWC-1 SUPPORT CHUCK FOR HOLLYWOOD HUSTLER COMBO CUTTER



ROOT CUTTER HUBS

- RSH-1A 1" HUB FOR HYDRAULIC ROOT CUTTER STD. SAW 1/8"
- RSH-1B 1" HUB FOR HYDRAULIC ROOT CUTTER HD. SAW 3/16"
- RSH-58 5/8" HUB FOR HYDRAULIC ROOT CUTTER SAW
- 3BHC-1 3 BLADE CHUCK FOR 1" HYD. ROOT CUTTER
- 3BHC-2 3 BLADE CHUCK FOR 5/8" HYD. ROOT CUTTER
- WCH-1 1" HUB WITH WINTERS CHUCK FOR 2 SAWS



ROOT SAW BLADES ONLY. FOR ROOTS SAWS, PLEASE SEE PAGE 18

STANDARD CONCAVE ROOT SAW BLADES

- CRS-3B 3" 3" Concave Root Saw blade only
- CRS-4B 4" 4" Concave Root Saw blade only
- CRS-5B 5" 5" Concave Root Saw blade only
- CRS-6B 6" 6" Concave Root Saw blade only
- CRS-8B 8" 8" Concave Root Saw blade only
- CRS-10B 10" 10" Concave Root Saw blade only
- CRS-12B 12" 12" Concave Root Saw blade only
- CRS-15B 15" 15" Concave Root Saw blade only
- CRS-18B 18" 18" Concave Root Saw blade only
- CRS-20B 20" 20" Concave Root Saw blade only



STANDARD FLAT ROOT SAWS BLADES

- FRS-3B 3" 3" Standard Flat Root Saw blade only
- FRS-4B 4" 4" Standard Flat Root Saw blade only
- FRS-6B 6" 6" Standard Flat Root Saw blade only
- FRS-8B 8" 8" Standard Flat Root Saw blade only
- FRS-10B 10" 10" Standard Flat Root Saw blade only
- FRS-12B 12" 12" Standard Flat Root Saw blade only
- FRS-15B 15" 15" Standard Flat Root Saw blade only
- FRS-18B 18" 18" Standard Flat Root Saw blade only
- FRS-20B 20" 20" Standard Flat Root Saw blade only



HEAVY DUTY CONCAVE ROOT SAWS BLADES

- HCRS-3B 3" 3" HD Concave Root Saw blade only
- HCRS-4B 4" 4" HD Concave Root Saw blade only
- HCRS-5B 5" 5" HD Concave Root Saw blade only
- HCRS-6B 6" 6" HD Concave Root Saw blade only
- HCRS-8B 8" 8" HD Concave Root Saw blade only
- HCRS-10B 10" 10" HD Concave Root Saw blade only
- HCRS-12B 12" 12" HD Concave Root Saw blade only
- HCRS-15B 15" 15" HD Concave Root Saw blade only
- HCRS-18B 18" 18" HD Concave Root Saw blade only
- HCRS-20B 20" 20" HD Concave Root Saw blade only



HEAVY DUTY FLAT ROOT SAWS BLADES

- HFRS-3B 3" 3" HD Flat Root Saw blade only
- HFRS-4B 4" 4" HD Flat Root Saw blade only
- HFRS-5B 5" 5" HD Flat Root Saw blade only
- HFRS-6B 6" 6" HD Flat Root Saw blade only
- HFRS-8B 8" 8" HD Flat Root Saw blade only
- HFRS-10B 10" 10 HD Flat Root Saw blade only
- HFRS-12 2" 12" HD Flat Root Saw blade only
- HFRS-15 5" 15" HD Flat Root Saw blade only
- HFRS-18 18" 18" HD Flat Root Saw blade only
- HFRS-20 20" 20" HD Flat Root Saw blade only



CARBIDE TOOTHED CONCAVE ROOT SAWS (EVERY 5TH ON FRONT, 10TH ON REAR)

SCS-6	6"	6" Carbide Tipped Concave Root Saw Blade
SCS-8	8"	8" Carbide Tipped Concave Root Saw Blade
SCS-10	10"	10" Carbide Tipped Concave Root Saw Blade
SCS-12	12"	12" Carbide Tipped Concave Root Saw Blade
SCS-15	15"	15" Carbide Tipped Concave Root Saw Blade
SCS-18	18"	18" Carbide Tipped Concave Root Saw Blade



CARBIDE TOOTHED FLAT ROOT SAWS

SCFS-6	6"	6" Carbide Tipped Flat Root Saw Blade Every
SCFS-8	8"	8" Carbide Tipped Flat Root Saw Blade Every
SCFS-10	10"	10" Carbide Tipped Flat Root Saw Blade Every
SCFS-12	12"	12" Carbide Tipped Flat Root Saw Blade Every
SCFS-15	15"	15" Carbide Tipped Flat Root Saw Blade Every
SCFS-18	18"	18" Carbide Tipped Flat Root Saw Blade Every



DIAMOND TAP CUTTERS

DTC-6	6"	DIAMOND TAP CUTTER
DTC-8	8"	DIAMOND TAP CUTTER
DTC-10	10"	DIAMOND TAP CUTTER
DTC-12	12"	DIAMOND TAP CUTTER
DTC-15	15"	DIAMOND TAP CUTTER



PVC TAP CUTTERS

CTS-6	6"	PVC TAP CUTTER
CTS-8	8"	PVC TAP CUTTER
CTS-10	10"	PVC TAP CUTTER
CTS-12	12"	PVC TAP CUTTER
CTS-15	15"	PVC TAP CUTTER



ARROW DIAMOND TIPPED CUTTERS WITH 1" HUB & KEYWAY (Calcium Carbonate Cutter)

ADC-6	6"	ARROW DIAMOND POINT CUTTER
ADC-8	8"	ARROW DIAMOND POINT CUTTER
ADC-10	10"	ARROW DIAMOND POINT CUTTER
ADC-12	12"	ARROW DIAMOND POINT CUTTER
ADC-15	15"	ARROW DIAMOND POINT CUTTER



SUPER DUTY LARGE DIAMETER ROOT SAWS WITH SPOKES.

SCRS-12	12"	12" CONCAVE HD SAW WITH 3 SPOKES AND 1" HUB
SCRS-15	15"	15" CONCAVE HD SAW WITH 3 SPOKES AND 1" HUB
SCRS-18	18"	18" CONCAVE HD SAW WITH 3 SPOKES AND 1" HUB
SCRS-20	20"	20" CONCAVE HD SAW WITH 3 SPOKES AND 1" HUB
SCRS-22	22"	22" CONCAVE HD SAW WITH 3 SPOKES AND 1" HUB
SCRS-24	24"	24" CONCAVE HD SAW WITH 3 SPOKES AND 1" HUB



NOZZLE EXTENSIONS

SSE-1	STRAIGHT STYLE LIGHTWEIGHT NOZZLE EXTENSION 1" X 13" LONG
SSE-3/4	STRAIGHT STYLE LIGHTWEIGHT NOZZLE EXTENSION 3/4" X 13" LONG



4-FINNED NOZZLE EXTENSIONS 1"

FE-41	4"	1" x 4" FINNED NOZZLE EXTENSION
FE-61	6"	1" x 6" FINNED NOZZLE EXTENSION
FE-81	8"	1" x 8" FINNED NOZZLE EXTENSION
FE-101	10"	1" x 10" FINNED NOZZLE EXTENSION
FE-121	12"	1" x 12" FINNED NOZZLE EXTENSION
FE-151	15"	1" x 15" FINNED NOZZLE EXTENSION



4-FINNED NOZZLE EXTENSIONS 3/4"

FE-434	4"	3/4" x 4" FINNED NOZZLE EXTENSION
FE-634	6"	3/4" x 6" FINNED NOZZLE EXTENSION
FE-834	8"	3/4" x 8" FINNED NOZZLE EXTENSION
FE-1034	10"	3/4" x 10" FINNED NOZZLE EXTENSION
FE-1234	12"	3/4" x 12" FINNED NOZZLE EXTENSION



4-FINNED NOZZLE EXTENSIONS 1/2"

FE-412	4"	1/2" x 4" FINNED NOZZLE EXTENSION
FE-612	6"	1/2" x 6" FINNED NOZZLE EXTENSION
FE-812	8"	1/2" x 8" FINNED NOZZLE EXTENSION



6-FINNED HEAVY DUTY NOZZLES EXTENSIONS

FE-61-6	6"	1" X 6"	6 FINNED, 3/16" THICK HEAVY DUTY EXTENSION
FE-81-6	8"	1" X 6"	6 FINNED, 3/16" THICK HEAVY DUTY EXTENSION
FE-101-6	10"	1" X 6"	6 FINNED, 3/16" THICK HEAVY DUTY EXTENSION
FE-121-6	12"	1" X 6"	6 FINNED, 3/16" THICK HEAVY DUTY EXTENSION
FE-151-6	15"	1" X 6"	6 FINNED, 3/16" THICK HEAVY DUTY EXTENSION
FE-181-6	18"	1" X 6"	6 FINNED, 3/16" THICK HEAVY DUTY EXTENSION



6-WIRE NOZZLE EXTENSIONS 1"

WNE-41	4"	1" x 4"	6 WIRE NOZZLE EXTENSION
WNE-61	6"	1" x 6"	6 WIRE NOZZLE EXTENSION
WNE-81	8"	1" x 8"	6 WIRE NOZZLE EXTENSION
WNE-101	10"	1" x 10"	6 WIRE NOZZLE EXTENSION
WNE-121	12"	1" x 12"	6 WIRE NOZZLE EXTENSION
WNE-151	15"	1" X 15"	6 WIRE NOZZLE EXTENSION
WNE-181	18"	1" X 18"	6 WIRE NOZZLE EXTENSION
WNE-201	20"	1" X 20"	6 WIRE NOZZLE EXTENSION



6-WIRE NOZZLE EXTENSIONS 3/4"

WNE-434	4"	3/4" x 4"	6 WIRE NOZZLE EXTENSION
WNE-634	6"	3/4" x 6"	6 WIRE NOZZLE EXTENSION
WNE-834	8"	3/4" x 8"	6 WIRE NOZZLE EXTENSION
WNE-1034	10"	3/4" x 10"	6 WIRE NOZZLE EXTENSION
WNE-1234	12"	3/4" x 12"	6 WIRE NOZZLE EXTENSION
WNE-1534	15"	3/4" x 15"	6 WIRE NOZZLE EXTENSION



6-WIRE NOZZLE EXTENSIONS 1/2"

WNE-412	4"	1/2" x 4"	6 WIRE NOZZLE EXTENSION
WNE-612	6"	1/2" x 6"	6 WIRE NOZZLE EXTENSION

4-WIRE NOZZLE EXTENSIONS 1"

W4-1	4"	1" x 4"	4 WIRE NOZZLE EXTENSION
W6-1	6"	1" x 6"	4 WIRE NOZZLE EXTENSION
W8-1	8"	1" x 8"	4 WIRE NOZZLE EXTENSION
W10-1	10"	1" x 10"	4 WIRE NOZZLE EXTENSION
W12-1	12"	1" x 12"	4 WIRE NOZZLE EXTENSION

4-WIRE NOZZLE EXTENSIONS 3/4"

W4-34	4"	3/4" x 4"	4 WIRE NOZZLE EXTENSION
W6-34	6"	3/4" x 6"	4 WIRE NOZZLE EXTENSION
W8-34	8"	3/4" x 8"	4 WIRE NOZZLE EXTENSION
W10-34	10"	3/4" x 10"	4 WIRE NOZZLE EXTENSION
W12-34	12"	3/4" x 12"	4 WIRE NOZZLE EXTENSION

4-WIRE NOZZLE EXTENSIONS 1/2"

W4-12	4"	1/2" x 4"	4 WIRE NOZZLE EXTENSION
W6-12	6"	1/2" x 6"	4 WIRE NOZZLE EXTENSION
W8-12	8"	1/2" x 8"	4 WIRE NOZZLE EXTENSION
W10-12	10"	1/2" x 10"	4 WIRE NOZZLE EXTENSION

FOOTBALL STYLE NOZZLE EXTENSIONS 1"

NFL-41	4"	1" x 4"	FOOTBALL NOZZLE EXTENSION
NFL-61	6"	1" x 6"	FOOTBALL NOZZLE EXTENSION
NFL-81	8"	1" x 8"	FOOTBALL NOZZLE EXTENSION
NFL-101	10"	1" x 10"	FOOTBALL NOZZLE EXTENSION
NFL-121	12"	1" x 12"	FOOTBALL NOZZLE EXTENSION

FOOTBALL STYLE NOZZLE EXTENSIONS 3/4"

NFL-434	4"	3/4" x 4"	FOOTBALL NOZZLE EXTENSION
NFL-634	6"	3/4" x 6"	FOOTBALL NOZZLE EXTENSION
NFL-834	8"	3/4" x 8"	FOOTBALL NOZZLE EXTENSION
NFL-1034	10"	3/4" x 10"	FOOTBALL NOZZLE EXTENSION
NFL-1234	12"	3/4" x 12"	FOOTBALL NOZZLE EXTENSION

FOOTBALL STYLE NOZZLE EXTENSIONS 1/2"

NFL-412	4"	1/2" x 4"	FOOTBALL NOZZLE EXTENSION
NFL-612	6"	1/2" x 6"	FOOTBALL NOZZLE EXTENSION
NFL-812	8"	1/2" x 8"	FOOTBALL NOZZLE EXTENSION
NFL-1012	10"	1/2" x 10"	FOOTBALL NOZZLE EXTENSION

SUPER SHORT 8" FOOTBALL STYLE NOZZEL EXT FOR 1" HOSE

NFL-41SS	4"	4"	FOOTBALL NOZZLE EXTENSION 8" LONG
NFL-61SS	6"	6"	FOOTBALL NOZZLE EXTENSION 8" LONG
NFL-81SS	8"	8"	FOOTBALL NOZZLE EXTENSION 8" LONG



FINNED NOZZLE EXTENSION WITH WHEELS 1"

WE-61	6"	1" WHEELED NOZZLE EXTENSION FOR 6" AND UP
WE-81	8"	1" WHEELED NOZZLE EXTENSION FOR 8" AND UP
WE-101	10"	1" WHEELED NOZZLE EXTENSION FOR 10" AND UP
WE-121	12"	1" WHEELED NOZZLE EXTENSION FOR 12" AND UP
WE-151	15"	1" WHEELED NOZZLE EXTENSION FOR 15" AND UP



FINNED NOZZLE EXTENSION WITH WHEELS 3/4"

WE-634	6"	3/4" WHEELED NOZZLE EXTENSION FOR 6" AND UP
WE-834	8"	3/4" WHEELED NOZZLE EXTENSION FOR 8" AND UP
WE-1034	10"	3/4" WHEELED NOZZLE EXTENSION FOR 10" AND UP
WE-1234	12"	3/4" WHEELED NOZZLE EXTENSION FOR 12" AND UP
WE-1534	15"	3/4" WHEELED NOZZLE EXTENSION FOR 15" AND UP



HEAVY DUTY TUBE STYLE EXTENSION (12" Long)

TSE-1/2	8 lbs	HEAVY DUTY TUBE STYLE NOZZLE EXTENSION 1/2"
TSE-3/4	9 lbs	HEAVY DUTY TUBE STYLE NOZZLE EXTENSION 3/4"
TSE-1	10 lbs	HEAVY DUTY TUBE STYLE NOZZLE EXTENSION 1"



SHORT 10 LEG PROOFERS

S-6	6"	SHORT PROOFER 6" O.D. X 1"
S-7.5	7.5"	SHORT PROOFER 7.5" O.D. X 1"
S-8	8"	SHORT PROOFER 8" O.D. X 1"
S-9.5	9.5"	SHORT PROOFER 9.5" O.D. X 1"
S-10	10"	SHORT PROOFER 10" O.D. X 1"
S-11.5	11.5"	SHORT PROOFER 11.5" O.D. X 1"
S-12	12"	SHORT PROOFER 12" O.D. X 1"
S-15	15"	SHORT PROOFER 15" O.D. X 1"
S-18	18"	SHORT PROOFER 18" O.D. X 1"



FOR 3/4" POOFER, ADD "34" AFTER PART NUMBER. SAME PRICE.

LONG 10 LEGGED PROOFERS (REMOVABLE)

L-6	6"	LONG PROOFER 6" O.D. X 1"
L-7.5	7.5"	LONG PROOFER 7.5" O.D. X 1"
L-8	8"	LONG PROOFER 8" O.D. X 1"
L-9.5	9.5"	LONG PROOFER 9.5" O.D. X 1"
L-10	10"	LONG PROOFER 10" O.D. X 1"
L-11.5	11.5"	LONG PROOFER 11.5" O.D. X 1"
L-12	12"	LONG PROOFER 12" O.D. X 1"
L-15	15"	LONG PROOFER 15" O.D. X 1"
L-18	18"	LONG PROOFER 18" O.D. X 1"



FOR 3/4" POOFER, ADD "34" AFTER PART NUMBER. SAME PRICE.

SECTIONAL AND CONTINUOUS ROD TOOLS AND ACCESSORIES

ADAPTER RODS

AR-1-1	5/16"	Adapter Rod
AR-1-2	3/8"	Adapter Rod
AR-1-SS	5/16"	Super Short
AR-1-2SS	3/8"	Super Short



PREMIUM PUMA RODS

STR-1-1	5/16" X 36"	Premium Sewer Rod Complete With Coupling
STR-1-2	5/16" X 39"	Premium Sewer Rod Complete With Coupling
STR-1-3	5/16" X 48"	Premium Sewer Rod Complete With Coupling
STR-1-4	5/16" X 60"	Premium Sewer Rod Complete With Coupling
STR-1-5	5/16" X 72"	Premium Sewer Rod Complete With Coupling
STR-1-6	3/8" X 36"	Premium Sewer Rod Complete With Coupling
STR-1-7	3/8" X 39"	Premium Sewer Rod Complete With Coupling
STR-1-8	3/8" X 48"	Premium Sewer Rod Complete With Coupling
STR-1-9	3/8" X 60"	Premium Sewer Rod Complete With Coupling
STR-1-10	3/8" X 72"	Premium Sewer Rod Complete With Coupling



PUMA SILVER RODS

STB-1-1	5/16" X 36"	Sewer Rod Complete With Coupling
STB-1-2	5/16" X 39"	Sewer Rod Complete With Coupling
STB-1-3	5/16" X 48"	Sewer Rod Complete With Coupling
STB-1-4	5/16" X 60"	Sewer Rod Complete With Coupling
STB-1-5	5/16" X 72"	Sewer Rod Complete With Coupling
STB-1-6	3/8" X 36"	Sewer Rod Complete With Coupling
STB-1-7	3/8" X 39"	Sewer Rod Complete With Coupling
STB-1-8	3/8" X 48"	Sewer Rod Complete With Coupling
STB-1-9	3/8" X 72"	Sewer Rod Complete With Coupling



QUICK COUPLE RODS.

ALL 5/16" RODS ARE AVAILABLE WITH QUICK CONNECT DISCONNECT SPRING LOADED PIN COUPLINGS. PLEASE ADD "R" TO PART NUMBER AND ADD \$10.00 TO EACH ROD.



ROD TOOLS

PICK UP TOOLS

P1-1	5/16"	Pick Up Tool For Sectional Rod
P1-2	3/8"	Pick Up Tool For Sectional Rod



SPEAR HEADS

B2-1	2"	2" Spear Head with 5/16" Adaptor rod and coupling
B2-2	2"	2" Spear Head with 3/8" Adaptor rod and coupling
B4-1	4"	4" Spear Head with 5/16" Adaptor rod and coupling
B4-2	4"	4" Spear Head with 3/8" Adaptor rod and coupling



ASSEMBLY TOOLS

T1-1	5/16"	Assembly Wrench
T1-2	3/8"	Assembly Wrench
T2-1	5/16"	Assembly Turning Handle
T2-2	3/8"	Assembly Turning Handle



PULL OUT AND TURNING TOOLS

T3-1	5/16"	Pull Out Tool
T3-2	3/8"	Pull Out Tool
T4-1	5/16"	Pull Out & Twisting Handle
T4-2	3/8"	Pull Out & Twisting Handle
T5-1		Bar Turning Handle FOR 5/16" AND 3/8"
T8		Round Rod Puller Fits tools 1/4" to 3/8" Rod
T11	5/16"	Rod Turning Ratchet single for 5/16" rods
T12	5/16"	Rod Turning Ratchet one man double
T13	3/8"	Rod Turning Ratchet single for 3/8" rods
T14	3/8"	Rod Turning Ratchet one man double



SPECIAL BORING TOOLS

T6-1	5/16"	Loop Swivel Tool
T6-2	3/8"	Loop Swivel Tool
T7-1	5/16"	Sand Leader With Adapter Rod & Couplings
T7-2	3/8"	Sand Leader With Adapter Rod & Couplings
T9-1	5/16"	Bullet Tool With Adapter Rod
T9-2	3/8"	Bullet Tool With Adapter Rod
T10-1	5/16"	Pilot Bullet Tool With Pullout Swivel With Adapter Rod
T10-2	3/8"	Pilot Bullet Tool With Pullout Swivel With Adapter Rod
T15-1	5/16"	"Winters" Root saw coupling. Combine with any 2 root saw
T15-2	3/8"	Winters" Root saw coupling. Combine with any 2 root saw
LL-1	5/16"	5/16" LATERAL LOCATOR
LL-2	3/8"	3/8" LATERAL LOCATOR



FOR ANY TOOL WITH SET SCREW COUPLING ADD "SS" AND EITHER 3 FOR .375, 4 FOR .393, 5 FOR .415 OR 6 FOR .461. USE 3/8" PRICE FOR EXAMPLE: T9-SS-3 BULLET TOOL WITH .375 SET SCREW COUPLING.

CLEANING TOOLS

ROUND WIRE CORKSCREWS

F1-1	1-1/2"	Use With 5/16" Rod
F1-2	1-1/2"	Use With 3/8" Rod
F2-1	2"	Use With 5/16" Rod
F2-2	2"	Use With 3/8" Rod
F3-1	3"	Use With 5/16" Rod
F3-2	3"	Use With 3/8" Rod
F4-1	3-1/2"	Use With 5/16" Rod
F4-2	3-1/2"	Use With 3/8" Rod
F5-1	5"	Use With 5/16" Adaptor Rod
F5-2	5"	Use With 3/8" Rod
F6-1	6"	Use With 5/16" Adaptor Rod
F6-2	6"	Use With 3/8" Rod



DOUBLE ROUND WIRE CORKSCREWS

FD3-1	3"	Use With 5/16" Rod
FD3-2	3"	Use With 3/8" Rod
FD4-1	4"	Use With 5/16" Rod
FD4-2	4"	Use With 3/8" Rod
FD6-1	6"	Use With 5/16" Rod
FD6-2	6"	Use With 3/8" Rod



SAND CORKSCREWS

G-3-1	3"	Sand Corkscrew Use With 5/16" Rod
G-3-2	3"	Sand Corkscrew Use With 3/8" Rod



Note: For any cleaning tool you can buy the tool only less the coupling and adapter rod by adding a "B" after the part number and then deduct \$10.00

AUGERS

A2-1	2"	2" Auger for 5/16" rods
A2-2	2"	2" Auger for 3/8" rods
A3-1	3"	3" Auger for 5/16" rods
A3-2	3"	3" Auger for 3/8" rods
A4-1	4"	4" Auger for 5/16" rods
A4-2	4"	4" Auger for 3/8" rods
A5-1	5"	5" Auger for 5/16" rods
A5-2	5"	5" Auger for 3/8" rods
A6-1	6"	6" Auger for 5/16" rods
A6-2	6"	6" Auger for 3/8" rods
A8-1	8"	8" Auger for 5/16" rods
A8-2	8"	8" Auger for 3/8" rods
A10-1	10"	10" Auger for 5/16" rods
A10-2	10"	10" Auger for 3/8" rods



Set Screw ends: For Set Screw coupling add "SS" and either 3 for .375, 4 for .393, 5 for .415 or 6 for .461 rod

Direct Hook ends: For direct hook end add "DH" and either 3 for .375, 4 for .393, 5 for .415 or 6 for .461 rod

SQUARE BAR CORKSCREWS

E2-1	2"	2" Square Bar corkscrew for 5/16" rod
E2-2	2"	2" Square Bar corkscrew for 3/8" rod
E3-1	3"	3" Square Bar corkscrew for 5/16" rod
E3-2	3"	3" Square Bar corkscrew for 3/8" rod
E4-1	4"	4" Square Bar corkscrew for 5/16" rod
E4-2	4"	4" Square Bar corkscrew for 3/8" rod
E5-1	5"	5" Square Bar corkscrew for 5/16" rod
E5-2	5"	5" Square Bar corkscrew for 3/8" rod
E6-1	6"	6" Square Bar corkscrew for 5/16" rod
E6-2	6"	6" Square Bar corkscrew for 3/8" rod
E8-1	8" Std.	8" Square Bar corkscrew for 5/16" rod
E8-2	8" Std.	8" Square Bar corkscrew for 3/8" rod
E8-4	8" H.D.	8" HD Square Bar corkscrew for 5/16" rod
E8-5	8" H.D.	8" HD Square Bar corkscrew for 3/8" rod
E10-1	10"	10" Square Bar corkscrew for 5/16" rod
E10-2	10"	10" Square Bar corkscrew for 3/8" rod
E12-1	12"	12" Square Bar corkscrew for 5/16" rod
E12-2	12"	12" Square Bar corkscrew for 3/8" rod



Set Screw ends: For Set Screw coupling add "SS" and either 3 for .375, 4 for .393, 5 for .415 or 6 for .461 rod

Direct Hook ends: For direct hook end add "DH" and either 3 for .375, 4 for .393, 5 for .415 or 6 for .461 rod

ROOT SAWS

CONCAVE ROOT SAW STANDARD

CRS-3-1	3"	3" Concave Root Saw for 5/16" rod
CRS-3-2	3"	3" Concave Root Saw for 3/8" rod
CRS-4-1	4"	4" Concave Root Saw for 5/16" rod
CRS-4-2	4"	4" Concave Root Saw for 3/8" rod
CRS-5-1	5"	5" Concave Root Saw for 5/16" rod
CRS-5-2	5"	5" Concave Root Saw for 3/8" rod
CRS-6-1	6"	6" Concave Root Saw for 5/16" rod
CRS-6-2	6"	6" Concave Root Saw for 3/8" rod
CRS-8-1	8"	8" Concave Root Saw for 5/16" rod
CRS-8-2	8"	8" Concave Root Saw for 3/8" rod
CRS-10-1	10"	10" Concave Root Saw for 5/16" rod
CRS-10-2	10"	10" Concave Root Saw for 3/8" rod
CRS-12-1	12"	12" Concave Root Saw for 5/16" rod
CRS-12-2	12"	12" Concave Root Saw for 3/8" rod
CRS-15-1	15"	15" Concave Root Saw for 5/16" rod
CRS-15-2	15"	15" Concave Root Saw for 3/8" rod
CRS-18-1	18"	18" Concave Root Saw for 5/16" rod
CRS-18-2	18"	18" Concave Root Saw for 3/8" rod
CRS-20-1	20"	20" Concave Root Saw for 5/16" rod
CRS-20-2	20"	20" Concave Root Saw for 3/8" rod

FOR BLADE ONLY ADD "B" AFTER PART NO. AND DEDUCT \$10.00

Set Screw ends: For Set Screw coupling add "SS" and either 3 for .375, 4 for .393, 5 for .415 or 6 for .461 rod

Direct Hook ends: For direct hook end add "DH" and either 3 for .375, 4 for .393, 5 for .415 or 6 for .461 rod



STANDARD DUTY FLAT ROOT SAWS

FRS-3-1	3"	3" Standard Flat Root Saw for 5/16" rod
FRS-3-2	3"	3" Standard Flat Root Saw for 3/8" rod
FRS-4-1	4"	4" Standard Flat Root Saw for 5/16" rod
FRS-4-2	4"	4" Standard Flat Root Saw for 3/8" rod
FRS-6-1	6"	6" Standard Flat Root Saw for 5/16" rod
FRS-6-2	6"	6" Standard Flat Root Saw for 3/8" rod
FRS-8-1	8"	8" Standard Flat Root Saw for 5/16" rod
FRS-8-2	8"	8" Standard Flat Root Saw for 3/8" rod
FRS-10-1	10"	10" Standard Flat Root Saw for 5/16" rod
FRS-10-2	10"	10" Standard Flat Root Saw for 3/8" rod
FRS-12-1	12"	12" Standard Flat Root Saw for 5/16" rod
FRS-12-2	12"	12" Standard Flat Root Saw for 3/8" rod
FRS-15-1	15"	15" Standard Flat Root Saw for 5/16" rod
FRS-15-2	15"	15" Standard Flat Root Saw for 3/8" rod
FRS-18-1	18"	18" Standard Flat Root Saw for 5/16" rod
FRS-18-2	18"	18" Standard Flat Root Saw for 3/8" rod
FRS-20-1	20"	20" Standard Flat Root Saw for 5/16" rod
FRS-20-2	20"	20" Standard Flat Root Saw for 3/8" rod

Set Screw ends: For Set Screw coupling add "SS" and either 3 for .375, 4 for .393, 5 for .415 or 6 for .461 rod

Direct Hook ends: For direct hook end add "DH" and either 3 for .375, 4 for .393, 5 for .415 or 6 for .461 rod



HEAVY DUTY CONCAVE ROOT SAWS

HCRS-3-1	3"	3" HD Concave Root Saw for 5/16" rod
HCRS-3-2	3"	3" HD Concave Root Saw for 3/8" rod
HCRS-4-1	4"	4" HD Concave Root Saw for 5/16" rod
HCRS-4-2	4"	4" HD Concave Root Saw for 3/8" rod
HCRS-5-1	5"	5" HD Concave Root Saw for 5/16" rod
HCRS-5-2	5"	5" HD Concave Root Saw for 3/8" rod
HCRS-6-1	6"	6" HD Concave Root Saw for 5/16" rod
HCRS-6-2	6"	6" HD Concave Root Saw for 3/8" rod
HCRS-8-1	8"	8" HD Concave Root Saw for 5/16" rod
HCRS-8-2	8"	8" HD Concave Root Saw for 3/8" rod
HCRS-10-1	10"	10" HD Concave Root Saw for 5/16" rod
HCRS-10-2	10"	10" HD Concave Root Saw for 3/8" rod
HCRS-12-1	12"	12" HD Concave Root Saw for 5/16" rod
HCRS-12-2	12"	12" HD Concave Root Saw for 3/8" rod
HCRS-15-1	15"	15" HD Concave Root Saw for 5/16" rod
HCRS-15-2	15"	15" HD Concave Root Saw for 3/8" rod
HCRS-18-1	18"	18" HD Concave Root Saw for 5/16" rod
HCRS-18-2	18"	18" HD Concave Root Saw for 3/8" rod
HCRS-20-1	20"	20" HD Concave Root Saw for 5/16" rod
HCRS-20-2	20"	20" HD Concave Root Saw for 3/8" rod

Set Screw ends: For Set Screw coupling add "SS" and either 3 for .375, 4 for .393, 5 for .415 or 6 for .461 rod

Direct Hook ends: For direct hook end add "DH" and either 3 for .375, 4 for .393, 5 for .415 or 6 for .461 rod



HEAVY DUTY FLAT ROOT SAWS

HFRS-3-1	3"	3" HD Flat Root Saw for 5/16" rod
HFRS-3-2	3"	3" HD Flat Root Saw for 3/8" rod
HFRS-4-1	4"	4" HD Flat Root Saw for 5/16" rod
HFRS-4-2	4"	4" HD Flat Root Saw for 3/8" rod
HFRS-5-1	5"	5" HD Flat Root Saw for 5/16" rod
HFRS-5-2	5"	5" HD Flat Root Saw for 3/8" rod
HFRS-6-1	6"	6" HD Flat Root Saw for 5/16" rod
HFRS-6-2	6"	6" HD Flat Root Saw for 3/8" rod
HFRS-8-1	8"	8" HD Flat Root Saw for 5/16" rod
HFRS-8-2	8"	8" HD Flat Root Saw for 3/8" rod
HFRS-10-1	10"	10" HD Flat Root Saw for 5/16" rod
HFRS-10-2	10"	10" HD Flat Root Saw for 3/8" rod
HFRS-12-1	12"	12" HD Flat Root Saw for 5/16" rod
HFRS-12-2	12"	12" HD Flat Root Saw for 3/8" rod
HFRS-15-1	15"	15" HD Flat Root Saw for 5/16" rod
HFRS-15-2	15"	15" HD Flat Root Saw for 3/8" rod
HFRS-18-1	18"	18" HD Flat Root Saw for 5/16" rod
HFRS-18-2	18"	18" HD Flat Root Saw for 3/8" rod
HFRS-20-1	20"	20" HD Flat Root Saw for 5/16" rod
HFRS-20-2	20"	20" HD Flat Root Saw for 3/8" rod



Set Screw ends: For Set Screw coupling add "SS" and either 3 for .375, 4 for .393, 5 for .415 or 6 for .461 rod

Direct Hook ends: For direct hook end add "DH" and either 3 for .375, 4 for .393, 5 for .415 or 6 for .461 rod

ROOT SAW BLADES ONLY

STANDARD CONCAVE ROOT SAW BLADES

CRS-3B	3"	3" Concave Root Saw blade only
CRS-4B	4"	4" Concave Root Saw blade only
CRS-5B	5"	5" Concave Root Saw blade only
CRS-6B	6"	6" Concave Root Saw blade only
CRS-8B	8"	8" Concave Root Saw blade only
CRS-10B	10"	10" Concave Root Saw blade only
CRS-12B	12"	12" Concave Root Saw blade only
CRS-15B	15"	15" Concave Root Saw blade only
CRS-18B	18"	18" Concave Root Saw blade only
CRS-20B	20"	20" Concave Root Saw blade only



STANDARD FLAT ROOT SAWS BLADES

FRS-3B	3"	3" Standard Flat Root Saw blade only
FRS-4B	4"	4" Standard Flat Root Saw blade only
FRS-6B	6"	6" Standard Flat Root Saw blade only
FRS-8B	8"	8" Standard Flat Root Saw blade only
FRS-10B	10"	10" Standard Flat Root Saw blade only
FRS-12B	12"	12" Standard Flat Root Saw blade only
FRS-15B	15"	15" Standard Flat Root Saw blade only
FRS-18B	18"	18" Standard Flat Root Saw blade only
FRS-20B	20"	20" Standard Flat Root Saw blade only



HEAVY DUTY CONCAVE ROOT SAWS BLADES

HCRS-3B	3"	3" HD Concave Root Saw blade only
HCRS-4B	4"	4" HD Concave Root Saw blade only
HCRS-5B	5"	5" HD Concave Root Saw blade only
HCRS-6B	6"	6" HD Concave Root Saw blade only
HCRS-8B	8"	8" HD Concave Root Saw blade only
HCRS-10B	10"	10" HD Concave Root Saw blade only
HCRS-12B	12"	12" HD Concave Root Saw blade only
HCRS-15B	15"	15" HD Concave Root Saw blade only
HCRS-18B	18"	18" HD Concave Root Saw blade only
HCRS-20B	20"	20" HD Concave Root Saw blade only



HEAVY DUTY FLAT ROOT SAWS BLADES

HFRS-3B	3"	3" HD Flat Root Saw blade only
HFRS-4B	4"	4" HD Flat Root Saw blade only
HFRS-5B	5"	5" HD Flat Root Saw blade only
HFRS-6B	6"	6" HD Flat Root Saw blade only
HFRS-8B	8"	8" HD Flat Root Saw blade only
HFRS-10B	10"	10" HD Flat Root Saw blade only
HFRS-12B	12"	12" HD Flat Root Saw blade only
HFRS-15B	15"	15" HD Flat Root Saw blade only
HFRS-18B	18"	18" HD Flat Root Saw blade only
HFRS-20B	20"	20" HD Flat Root Saw blade only



SHARK TOOTH ROOT SAWS

STS-4-1	4"	4" Shark Tooth Saw for 5/16" rods
STS-4-2	4"	4" Shark Tooth Saw for 3/8" rods
STS-6-1	6"	6" Shark Tooth Saw for 5/16" rods
STS-6-2	6"	6" Shark Tooth Saw for 3/8" rods
STS-8-1	8"	8" Shark Tooth Saw for 5/16" rods
STS-8-2	8"	8" Shark Tooth Saw for 3/8" rods
STS-10-1	10"	10" Shark Tooth Saw for 5/16" rods
STS-10-2	10"	10" Shark Tooth Saw for 3/8" rods
STS-12-1	12"	12" Shark Tooth Saw for 5/16" rods
STS-12-2	12"	12" Shark Tooth Saw for 3/8" rods
STS-15-1	15"	15" Shark Tooth Saw for 5/16" rods
STS-15-2	15"	15" Shark Tooth Saw for 3/8" rods



PORCUPINES

D-4-1	4"	4" Porcupine turn type for 5/16" rods
D-4-2	4"	4" Porcupine turn type for 3/8" rods
D-6-1	6"	6" Porcupine turn type for 5/16" rods
D-6-2	6"	6" Porcupine turn type for 3/8" rods
D-8-1	8"	8" Porcupine turn type for 5/16" rods
D-8-2	8"	8" Porcupine turn type for 3/8" rods
D-10-1	10"	10" Porcupine turn type for 5/16" rods
D-10-2	10"	10" Porcupine turn type for 3/8" rods
D-12-1	12"	12" Porcupine turn type for 5/16" rods
D-12-2	12"	12" Porcupine turn type for 3/8" rods
D-15-1	15"	15" Porcupine turn type for 5/16" rods
D-15-2	15"	15" Porcupine turn type for 3/8" rods
D-18-1	18"	18" Porcupine turn type for 5/16" rods
D-18-2	18"	18" Porcupine turn type for 3/8" rods



ALSO AVAILABLE IN PULL TYPE. PP-6, PP-8, PP-10 ETC... SAME PRICE

SEWER BRUSH

C-4-1	4"	4" Steel Sewer Brush for 5/16" Rods
C-4-2	4"	4" Steel Sewer Brush for 3/8" Rods
C-6-1	6"	6" Steel Sewer Brush for 5/16" Rods
C-6-2	6"	6" Steel Sewer Brush for 3/8" Rods
C-8-1	8"	8" Steel Sewer Brush for 5/16" Rods
C-8-2	8"	8" Steel Sewer Brush for 3/8" Rods
C-10-1	10"	10" Steel Sewer Brush for 5/16" Rods
C-10-2	10"	10" Steel Sewer Brush for 3/8" Rods
C-12-1	12"	12" Steel Sewer Brush for 5/16" Rods
C-12-2	12"	12" Steel Sewer Brush for 3/8" Rods



3 BLADE CUTTERS CHUCKS

CH-1-1	5/16"	Chuck with Adapter Rod
CH-1-2	3/8"	Chuck with Adapter Rod
CH-1-3	0.375	Chuck with Set Screw Connection
CH-1-4	0.393	Chuck with Set Screw Connection
CH-1-5	0.415	Chuck with Set Screw Connection
CH-1-6	0.461	Chuck with Set Screw Connection



COMBO CUTTER WITH CURVED OR FLAT BLADES AND CONCAVE ROOT SAWS

SVC-6	6"	CITY COMBO CUTTER,INCLUDES BLADES AND SAW 5/16"
SVC-8	8"	CITY COMBO CUTTER,INCLUDES BLADES AND SAW 5/16"
SVC-10	10"	CITY COMBO CUTTER,INCLUDES BLADES AND SAW 5/16"
SVC-12	12"	CITY COMBO CUTTER,INCLUDES BLADES AND SAW 5/16"
SVC-15	15"	CITY COMBO CUTTER,INCLUDES BLADES AND SAW 5/16"



PUMA DOUBLE SIDED CURVED BLADES FOR 3 BLADE CUTTER

CB-4	4"	4" CURVED BLADE FOR 3 BLADE CHUCK. PRICE PER BLADE
CB-6	6"	6" CURVED BLADE FOR 3 BLADE CHUCK. PRICE PER BLADE
CB-8	8"	8" CURVED BLADE FOR 3 BLADE CHUCK. PRICE PER BLADE
CB-10	10"	10" CURVED BLADE FOR 3 BLADE CHUCK. PRICE PER BLADE
CB-12	12"	12" CURVED BLADE FOR 3 BLADE CHUCK. PRICE PER BLADE
CB-15	15"	15" CURVED BLADE FOR 3 BLADE CHUCK. PRICE PER BLADE
CB-18	18"	18" CURVED BLADE FOR 3 BLADE CHUCK. PRICE PER BLADE

FOR FULL SIZE ADD "FS" AND \$2.00 TO EACH BLADE

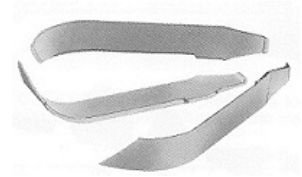

FLAT BLADES FOR 3 BLADE CUTTER

FB-4	4"	4" FLAT BLADE FOR 3 BLADE CHUCK. PRICE PER BLADE
FB-6	6"	6" FLAT BLADE FOR 3 BLADE CHUCK. PRICE PER BLADE
FB-8	8"	8" FLAT BLADE FOR 3 BLADE CHUCK. PRICE PER BLADE
FB-10	10"	10" FLAT BLADE FOR 3 BLADE CHUCK. PRICE PER BLADE
FB-12	12"	12" FLAT BLADE FOR 3 BLADE CHUCK. PRICE PER BLADE
FB-15	15"	15" FLAT BLADE FOR 3 BLADE CHUCK. PRICE PER BLADE
FB-18	18"	18" FLAT BLADE FOR 3 BLADE CHUCK. PRICE PER BLADE



POWER ROD DRIVE TRAILER AND ACCESSORIES

SPD-3	3 HP POWERDRIVE PowerDrive units include Speed-Chuck, specify 5/16" or 3/8"
SPD-6.5	6.5 HP POWERDRIVE PowerDrive units include Speed-Chuck, specify 5/16" or 3/8"
SPD-8	8 HP POWERDRIVE PowerDrive units include Speed-Chuck, specify 5/16" or 3/8"



RR-1-1	Rod Reel . made from 1/2" round bar. 500' capacity. Can be Used with either the tripod street stand or trailer type.
RR-1-2	Rod Reel Stand Street type. Guide tube with articulated Elbow. 3 legs support the Reel at perfect angle for pay-out.
RR-1-3	Rod Reel Stand Trailer type. Same guide tube but the mounting Plate to attached to trailer. Also can be modified to fit your truck.
RR-1-4	Lower Manhole rigid rod guide. Connets to 1.5" pipe to allow The rods to enter the sewer at the correct angle.
RR-1-5	Foot Jack support. Fits on the ends of guide.
RR-1-6	Back Jack support. Keeps pressure in the guide system by supporting the guide against back wall of manhole.
RR-1-7	Manhole Jack support. Used to support the 1.5" guide tube Against the mahole ring.
RR-1-8	COMPLETE MANHOLE SET-UP KIT WITH 21' OF GALVANIZED Comes with 21' of pipe in sections and RR1-4,RR1-5,RR1-6 and RR1-7.
H-10-1	Carry All Trailer. Can carry all your tools, rods and Powerdrive To the jobsite. Includes a lockable and an open tool box. Comes with a standard 2" ball hitch and
H-11-1	Stop, Tail, & Turning Lights
H-12-1	Pintle ring hitch
H-13-1	Electric Brakes



CONTINUOUS ROD AND RODDER ACCESSORIES

CONTINUOUS ROD GUIDE HOSES

LW-7	7'	Lightweight Hose Guide with Flex-Metallic liner
LW- 10	10'	Lightweight Hose Guide with Flex-Metallic liner
LW- 15	15'	Lightweight Hose Guide with Flex-Metallic liner
LW- 18	18'	Lightweight Hose Guide with Flex-Metallic liner
LW- 20	20'	Lightweight Hose Guide with Flex-Metallic liner
LW- 22	22'	Lightweight Hose Guide with Flex-Metallic liner
LW- 24	24'	Lightweight Hose Guide with Flex-Metallic liner
LW- 25	25'	Lightweight Hose Guide with Flex-Metallic liner



HD- 7	7'	Heavy Duty Hose Guide W/ Metallic Liner
HD- 10	10'	Heavy Duty Hose Guide W/ Metallic Liner
HD- 15	15'	Heavy Duty Hose Guide W/ Metallic Liner
HD- 18	18'	Heavy Duty Hose Guide W/ Metallic Liner
HD- 20	20'	Heavy Duty Hose Guide W/ Metallic Liner
HD- 22	22'	Heavy Duty Hose Guide W/ Metallic Liner
HD- 24	24'	Heavy Duty Hose Guide W/ Metallic Liner
HD-25	25'	Heavy Duty Hose Guide W/ Metallic Liner



HDS -7	7'	Heavy Duty Hose Guide W/ heavy duty steel Spring Liner
HDS- 10	10'	Heavy Duty Hose Guide W/ heavy duty steel Spring Liner
HDS- 15	15'	Heavy Duty Hose Guide W/ heavy duty steel Spring Liner
HDS- 18	18'	Heavy Duty Hose Guide W/ heavy duty steel Spring Liner
HDS- 20	20'	Heavy Duty Hose Guide W/ heavy duty steel Spring Liner
HDS- 22	22'	Heavy Duty Hose Guide W/ heavy duty steel Spring Liner
HDS- 25	25'	Heavy Duty Hose Guide W/ heavy duty steel Spring Liner



LW-15BF	15'	Below freezing Hose Guide with Flex-Metallic liner
LW- 18BF	18'	Below freezing Hose Guide with Flex-Metallic liner
LW- 20BF	20'	Below freezing Hose Guide with Flex-Metallic liner
LW- 22BF	22'	Below freezing Hose Guide with Flex-Metallic liner
LW- 25BF	25'	Below freezing Hose Guide with Flex-Metallic liner



SPECIAL HD
CAM-LOCK ENDS

example: WITH 2" HEAVY DUTY IRON CAM-LOCK FITTING
MALE END ADD "MI" TO PART NUMBER AND ADD
FEMALE END ADD "FI" TO PART NUMBER AND ADD
7' LIGHT ROD GUIDE HOSE WITH MALE X FEMALE
2" HEAVY DUTY IRON CAM LOCK FITTINGS
PART NO.LW-7MIFI \$ 480.00 + \$ 65.00 + \$ 85.00 = \$ 635



STEEL ENDS*

ANY ABOVE HOSE CAN BE ORDERED WITH STEEL ENDS
BY ADDING "SE" TO PART NUMBER AND ADDING
COMES WITH FEMALE END FOR HOSE GUIDE BELL AND
STEEL MALE END FOR RODDING MACHINE FEMALE



HGB	Hose Guide Bell
SPB	Single Prong Brace WITH CHAIN and rope
SPR	SINGLE PRONG BRACE WITH RING and rope
HGS	HOSE GUIDE STAND
SME	STEEL MALE END
SFE	STEEL FEMALE FOR BELL for HOSE GUIDE BELL
SCL-1	STEEL FEMALE X FEMALE STRAIGHT COUPLER.
SCL-2	SET OF CLAMPS FOR ATTACHED STEEL ENDS TO HOSE
SCL-3	ALUMINUM BELL END FOR GUIDE HOSE
SCL-4	ALUMINUM MALE END FOR GUIDE HOSE
SCL-5	INSERT GUIDE
SCL-6	LIGHTWEIGHT HOSE WITH FLEX-METALLIC LINER(PER FOOT)
SCL-7	HEAVY DUTY HOSE WITH FLEX-METALLIC LINER (PER FOOT)
SCL-8	FLEX-METALLIC LINER ONLY (PER FOOT)



CONTINUOUS ROD

STC-1-1	0.312	Continuous Rod	PRICE PER FOOT
STC-1-2	0.375	Continuous Rod	PRICE PER FOOT
STC-1-3	0.393	Continuous Rod	PRICE PER FOOT
STC-1-4	0.415	Continuous Rod	PRICE PER FOOT
STC-1-5	0.461	Continuous Rod	PRICE PER FOOT



CONTINUOUS ROD TRANSFER RACK

CRTR-1	6 SPOKE	Heavy duty transfer rack. 6 spoke and guide arm.
--------	---------	--



ROD, TOOL AND ADAPTER COUPLINGS

Adapter Couplings for connecting Continuous Rod to tools

AC-1-1	0.375	Set Screw Type, to 3/8" COARSE RH THREAD
AC-1-2	0.393	Set Screw Type, to 3/8" COARSE RH THREAD
AC-1-3	0.415	Set Screw Type, to 3/8" COARSE RH THREAD
AC-1-4	0.461	Set Screw Type, to 3/8" COARSE RH THREAD
AC-2-1	0.375	Fine LH thread Hook , to 5/16" COARSE RH THREAD
AC-2-2	0.393	Fine LH thread Hook , to 5/16" COARSE RH THREAD
AC-2-3	0.415	Fine LH thread Hook , to 5/16" COARSE RH THREAD
AC-2-4	0.461	Fine LH thread Hook , to 5/16" COARSE RH THREAD
AC-3-1	0.375	Set Screw Type, to 5/16" COARSE RH THREAD
AC-3-2	0.393	Set Screw Type, to 5/16" COARSE RH THREAD
AC-3-3	0.415	Set Screw Type, to 5/16" COARSE RH THREAD
AC-3-4	0.461	Set Screw Type, to 5/16" COARSE RH THREAD
AC-4-1	0.375	Fine LH thread hook , to 3/8" COARSE RH THREAD
AC-4-2	0.393	Fine LH thread hook , to 3/8" COARSE RH THREAD
AC-4-3	0.415	Fine LH thread hook , to 3/8" COARSE RH THREAD
AC-4-4	0.461	Fine LH thread hook , to 3/8" COARSE RH THREAD



Coupling Nuts

CN-1-1	5/16"	Course Thread Right Hand Nut
CN-1-2	5/16"	Fine Thread Left Hand Nut
CN-1-3	3/8"	Course Thread Right Hand Nut
CN-1-4	3/8"	Fine Thread Left Hand Nut
CN-1-5	0.375	Course Thread Right Hand Nut
CN-1-6	0.375	Fine Thread Left Hand Nut
CN-1-7	0.393	Course Thread Right Hand Nut
CN-1-8	0.393	Fine Thread Left Hand Nut
CN-1-9	0.415	Course Thread Right Hand Nut
CN-1-10	0.415	Fine Thread Left Hand Nut
CN-1-11	0.461	Course Thread Right Hand Nut
CN-1-12	0.461	Fine Thread Left Hand Nut



Couplings For Sectional And Continuous Rod

CC-1-1	5/16"	5/16" LH fine x Rh coarse coupling
CC-1-2	3/8"	3/8" LH fine x Rh coarse coupling



Couplings For Square Stock Corkscrew

CS-1-1	5/16"	To Be Used With Adapter Rods
CS-1-2	3/8"	To Be Used With Adapter Rods
CS-1-3	0.375	With Set Screw Connections
CS-1-4	0.393	With Set Screw Connections
CS-1-5	0.415	With Set Screw Connections
CS-1-6	0.461	With Set Screw Connections
CS-1-7	0.375	With Hook Type Connection
CS-1-8	0.393	With Hook Type Connection
CS-1-9	0.415	With Hook Type Connection
CS-1-10	0.461	With Hook Type Connection



ROD, TOOL AND ADAPTER COUPLINGS

Adapter Couplings for connecting Continuous Rod to tools

Couplings For STANDARD Root Saw

CR1-1	5/16"	To Be Used With Adapter Rods
CR1-2	3/8"	To Be Used With Adapter Rods
CR1-3	0.375	With Set Screw Connections
CR1-4	0.393	With Set Screw Connections
CR1-6	0.461	With Set Screw Connections
CR1-7	0.375	With Hook Type Connection
CR1-8	0.393	With Hook Type Connection
CR1-10	0.461	With Hook Type Connection



Couplings For HD Root Saw

CRHD-1	5/16"	To Be Used With Adapter Rods
CRHD-2	3/8"	To Be Used With Adapter Rods
CRHD-3	0.375	With Set Screw Connections
CRHD-4	0.393	With Set Screw Connections
CRHD-5	0.415	With Set Screw Connections
CRHD-6	0.461	With Set Screw Connections
CRHD-7	0.375	With Hook Type Connection
CRHD-8	0.393	With Hook Type Connection
CRHD-9	0.415	With Hook Type Connection
CRHD-10	0.461	With Hook Type Connection



Couplings For Augers -2", 3" & 4"

CA-1-1	5/16"	To Be Used With Adapter Rods
CA-1-2	3/8"	To Be Used With Adapter Rods
CA-1-3	0.375	With Set Screw Connections
CA-1-4	0.393	With Set Screw Connections
CA-1-5	0.415	With Set Screw Connections
CA-1-6	0.461	With Set Screw Connections
CA-1-7	0.375	With Hook Type Connection
CA-1-8	0.393	With Hook Type Connection
CA-1-9	0.415	With Hook Type Connection
CA-1-10	0.461	With Hook Type Connection



Couplings For Augers - 6" & 10" AND UP

CA-2-1	5/16"	To Be Used With Adapter Rods
CA-2-2	3/8"	To Be Used With Adapter Rods
CA-2-3	0.375	With Set Screw Connections
CA-2-4	0.393	With Set Screw Connections
CA-2-5	0.415	With Set Screw Connections
CA-2-6	0.461	With Set Screw Connections
CA-2-7	0.375	With Hook Type Connection
CA-2-8	0.393	With Hook Type Connection
CA-2-9	0.415	With Hook Type Connection
CA-2-10	0.461	With Hook Type Connection





PLUMBERS RODS

No. "5" Rods and Tools

P5-13	1/4" X 6'	NO. 5 PLUMBERS RODS. HEX COUPLING AND 1/4" X 6' LONG
P5-1		Rod Frame for no. 5 Rods
P5-2		2" Round Wire Coiled corkscrew
P5-3		3" Double Round Wire Coiled corkscrew
P5-4		4" Round Wire Coiled corkscrew
P5-5-2		2" Root Cutter with Spade blade
P5-5-3		3" Root Cutter with Spade Blade
P5-5-4		4" Root Cutter with Spade Blade
P5-6		2" spear head with coiled pig tail
P5-7		Pick-up tool with coiled pig tail
P5-8		Assembly tool for no. 5 rods
P5-9		Electric Drill adapter
P5-10		Pull out turning handle
P-5SET		Complete No. 5 set is comprised of:

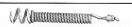
17each. P5-13 1/4" x 6' rods, 1 each of P5-1 Rod Frame, 1 each of P5-2 2" corkscrew, 1 each of P5-3 4" double corkscrew, 1 each of P5-4 4" corkscrew, 1 each of P5-5-3 3" Root Cutter , 1 each of P5-6 Spear Head, 1 each of P5-7 Pick-up Tool, 1 each of P5-8 Assembly tool, 1 each of P5-9 Electric Drill Adapter, 1 each of P5-10 turning handle
Add "B" to any tool above for a pig tail with a "B" nut. Then add \$3.50ea.



CORKSCREW FOR 2" PIPE: always the first tool to use to get the water running.
PART NO. P5-2



DOUBLE CORKSCREW: the second tool to use for roots.
PART NO. P5-3

CORKSCREW FOR 4" PIPE: for hard grease and roots.
PART NO. P5-4

ROOT CUTTER: shears off tough tap roots not pulled out.
PART NO. P5-5-3
PART NO. P5-5-4



SPEAR HEAD: for small waste lines packed with grease, rust.
PART NO. P5-6

PICK-UP TOOL: will easily remove a broken rod or tool from the line.
PART NO. P5-7

ASSEMBLY TOOL: used with Turning Handle for coupling or uncoupling.
PART NO. P5-8

ELECTRIC DRILL ADAPTOR: fits Jacobs chuck on electric drills 3/8" and larger. Very practical in many cases.
PART NO. P5-9

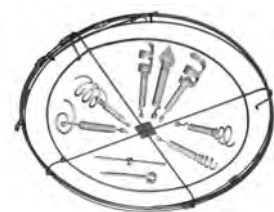
TURNING HANDLE: boring, pulling or pushing is done without losing tension.
PART NO. P5-10



"B" PLUMBERS RODS AND TOOLS

PB-1	1/4" X 6' "B" ROD COMPLETE (ROUND COUPLING)
PB-2	PICK UP TOOL
PB-3	4" CORKSCREW
PB-4	2" CORKSCREW
PB-5-3	3" ROOT CUTTER
PB-5-4	4" ROOT CUTTER
PB-6	SPEAR HEAD
PB-7	ASSEMBLY TOOL
PB-8	TURNING HANDLE
PB-9	4" TAPERED CORKSCREW(NOT IN SET)
PB-10	2" TAPERED CORKSCREW(NOT IN SET)



PB	COMPLETE "B" PLUMBERS SET SET INCLUDES 17 RODS AND 1 EACH OF ALL TOOLS ABOVE PB-9 AND PB-10
----	---

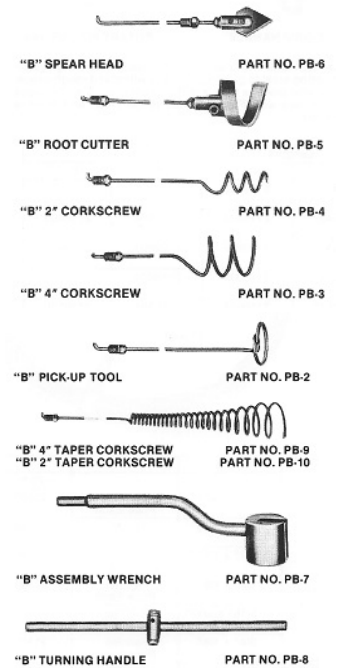

SPECIAL COILED SPRING ITEMS

SSU-1	1" O.D. OF 1/4" WIRE X 12" LONG WITH RH X LH 5/16" NUTS.
SSU-2	UNIVERSAL SPRINGS 1.25" DIA. X 12" L. W/ 5/16" LH X RH
SSCR-3	1" X 3' COILED ROD WITH RH X LH 5/16" NUTS
SCR-25	1" X 25' COILED ROD WITH 5/16" PIGS TAILS EACH SIDE
SCR-25S	SAME BUT WITH FEMALE 5/16" RH CRX516RH.
SCR-3A	1" X 3' COILED ROD WITH AUGER COUPLING X 5/16" PIG
PF-7	1" X 25' COILED ROD 1/4" PLUMBERTOOL MALE X FEMALE
PF-20M	1" X 3' LONG COILED ROD WITH 3" ROOT SAW X 5/16"
PF-21M	1" X 3' LONG COILED ROD WITH 4" ROOT SAW X 5/16"
PF-22M	1" X 3' LONG COILED ROD WITH 6" ROOT SAW X 5/16"



MISCELLANEOUS ITEMS

VALVES AND SWIVELS

BHK-1	S-21	1" 2-WAY BALL VALVE 5000 PSI
BHK-3/4	S-234	3/4" 2-WAY BALL VALVE 5000 PSI
BHK3-1	S-31	1" 3-WAY BALVE VALVE 5000 PSI
BHK3-3/3	S-334	3/4" 3-WAY BALL VALVE 5000 PSI

HIGH PRESSURE SWIVELS

SS-34E	3/4" 90° SWIVEL
SS-1E	1" 90° SWIVEL
SS-12E	1.25" 90° SWIVEL

VERNIER THROTTLE CABLES

VC-690-168	14' VERNIER THROTTLE CABLE
VC-690-180	15' VERNIER THROTTLE CABLE
VC-690-216	18' VERNIER THROTTLE CABLE
VC-690-240	20' VERNIER THROTTLE CABLE
VC-690-300	25' VERNIER THROTTLE CABLE
VC-690-360	30' VERNIER THROTTLE CABLE
VC-690-396	33' VERNIER THROTTLE CABLE
VC-690-420	35' VERNIER THROTTLE CABLE

WHS-3/4	6" CENTRALIZER SKID WITH HARD RAILS FOR 3/4" WARTHOG
WHS-1	6" CENTRALIZER SKID WITH HARD RAILS FOR 1 " WARTHOG
WHS-18	8" CENTRALIZER SKID WITH HARD RAILS FOR 1" WARTHOG
WHS-110	10" CENTRALIZER SKID WITH HARD RAILS FOR 1 " WARTHOG
WHS-112	12" CENTRALIZER SKID WITH HARD RAILS FOR 1 " WARTHOG



MANHOLE HOOKS

POOK		DOUBLE SIDED PICK AND MANHOLE HOOK. (patented)
MSRH-1		MANHOLE HOOK, TRIANGLE HANDLE, 39" LONG, 90°
MSRH-2		MANHOLE HOOK, TRIANGLE HANDLE, 27" LONG, FLAT
MSRH-3		MANHOLE HOOK, TRIANGLE HANDLE, 39" LONG, FLAT
MSRT-1		"T" HANDLE MANHOLE HOOK, 39" LONG, FLAT



SAND TRAPS

SST-6	6"	SAND TRAP WITH ROPE 25'
SST-8	8"	SAND TRAP WITH ROPE 25'
SST-10	10"	SAND TRAP WITH ROPE 25'
SST-12	12"	SAND TRAP WITH ROPE 25'
SST-15	15"	SAND TRAP WITH ROPE 25'
SST-18	18"	SAND TRAP WITH ROPE 25'
SST-20	20"	SAND TRAP WITH ROPE 25'

SEPTIC CLEANING TOOLS (All are fitted with a 3/8" female NPT pipe connection)

SV-5	9"	CURVED SPUD (TOP LEFT)
SV-1	9"	SLUDGE HOE WITH 2 HOLES (TOP MIDDLE)
SV-3	9"	SLUDGE SPUD (TOP RIGHT)
SV-6	15"	CURVED SPUD (MIDDLE LEFT)
SV-2	15"	SLUDGE HOE WITH 2 HOLES (CENTER)
SV-4	15"	SLUDGE SPUD (MIDDLE RIGHT)
SV-8	12"	SLUDGE RAKE WITH 2 HOLES AND TEETH (BOTTOM LEFT)
SV-7	16"	TANK SCRAPER (HALF MOON FOR TANKS) (BOTTOM RIGHT)
FE-1		ADAPTER TO CONNECT TOOLS TO FIBERGLASS POLES



MVBL-1 MAGNETIC VALVE BOX LIFTER. ROUND POLY HANDLE, 30" LONG. 190 LB. PULL



POLE SUPPORT BRACKET

This handy tool will keep your pole supported above the manhole rim. Hinged in the middle so it folds up and is easy to store. Interior rubber gasket keeps pole in place.

M-730 POLE SUPPORT BRACKET WITH HINGES

